

Distributed Generation Connection Guide: G98 & G99

March 2025 | Version 2.0

DOCUMENT CONTROL

Authorities

Version	Issue Date	Authorisation	Comments
Draft	06/11/23		First Draft issued for Consultation
Draft	11/01/2024		Consultation comments addressed and circulated.
Draft	12/03/2024		Additional comments provided and response too.
Draft	Feb 2025		DG Guide issued for 2025 Consultation
Final	March 2025		2025 version published

Change history

Version	Change reference	Description

Distribution

--

TABLE OF CONTENTS

Distributed Generation Connection Guide	9
An Introduction to the Distributed Generation Connection Guide	9
Current Regulations	20
Key terms in EREC G98 and EREC G99	22
Section 1: A Guide to the GB Power Sector	24
Introduction	24
The Commercial Structure of the Power Sector	24
The Physical Infrastructure of the Power Sector	24
Key Organisations	26
Network Innovation and Industry Developments	31
ENA Open Networks	31
New technologies	32
Where to Find More Information	32
Section 2: The Role of Distributed Generation	34
Introduction	34
What is driving Distributed Generation?	34
Benefits of Distributed Generation	35
Impacts of Distributed Generation	36
Where to Find More Information	36
Part 1: G98 Single and Multiple Premises	37
Is this the right Part of the guide for your installation?	37
Section 3: Distribution Generation Connection Process	39
Section 3.1: G98 Single Premises, An Overview of Getting Connected	39
Introduction	39
Getting Connected – Main Tasks	40
Getting Connected – IDNO’s Networks	41
Getting Connected - Connect Direct	41
Getting Connected - Type Testing Compliance	41

Section 3.2: G98 Multiple Premises, An Overview of Getting Connected	42
Introduction	42
Getting Connected – Main Tasks	43
Getting Connected – IDNO’s Networks	45
Getting Connected - Connect Direct.....	45
Getting Connected - Type Testing Compliance.....	45
Customer Service and Provision of Information	46
Section 3.3: G98 Additional Information	48
This section provides:	48
Getting Connected – Electricity Storage.....	48
Getting Connected – EREC G98 Exceptions	48
Getting Connected	49
Getting Connected – Vehicle to Grid	49
Where to Find More Information	50
Section 4: The Connection Application Process for G98	52
Section 4.1: G98 Single Premises, The Connection Application Process.....	52
Introduction	52
The Installation Document	52
Other Requirements	52
Section 4.2: G98 Multiple Premises, The Connection Application Process	53
Introduction	53
The Connection Application Form	53
Installation and Commissioning.....	53
The Installation Document	53
Other Requirements	54
Section 4.3: G98 Single & Multiple Premises, Additional Information on Compliance	55
Getting Connected – Guidance on Compliance	55
Section 5: G98 Costs and Charges	57
Section 5.1: G98 Single Premises, Costs and Charges	57

Use of System Charges	57
Section 5.2: G98 Multiple Premises, Costs and Charges	59
Introduction	59
Connection Charges	59
Connection Charges – Other Elements	59
Use of System Charges	61
Section 6: Selling Electricity (Smart Export Guarantee)	63
Section 6.1: G98 Selling Electricity (Smart Export Guarantee)	63
Introduction	63
Tariff Structure	63
Eligibility and Accreditation	64
Where to Find More Information	65
Part 2: G99 Type A & Type B-D	66
Is this the right Part of the guide for your installation?	66
Section 7: Distribution Generation Connection Process	70
Section 7.1: G99 Type A & Type B-D Power Generating Modules	70
This section provides:	70
Types of Power Generating Module	70
New and Existing Generation	72
Customer Service and Provision of Information	73
Section 7.2: G99 Type A, An Overview of Getting Connected	75
Introduction	75
Getting Connected – Main Tasks	77
Getting Connected - Validity of type testing	80
Getting Connected – Connect Direct	81
Getting Connected – IDNO’s Networks	81
Section 7.3: G99 Type B-D, An Overview of Getting Connected	82
Introduction	82

Connection Process Overview	82
Getting Connected – Project Planning Phase	84
Getting Connected - Information Phase	85
Getting Connected – Design Phase	85
Getting Connected – Construction Phase	89
Getting Connected – Testing and Commissioning	91
Getting Connected – Ongoing Responsibilities	92
Getting Connected – Connect Direct	93
Getting Connected - Changes to your Power Generating Module	93
Getting Connected – Medium and Large Power Stations	93
Registered Capacity	94
Section 7.4: G99, Additional Information	96
This section provides additional information relevant for G99 Power Generating Modules	96
IDNO's Networks	96
Electricity Storage	97
EREC G99 Exceptions	97
Getting Connected	98
Vehicle to Grid	98
Customer Island Operation	99
Where to Find More Information	100
Section 8: The Connection Application Process	101
Section 8.1: G99 Type A, The Connection Application Process	101
Introduction	101
The Standard Application Form	101
The Connection Offer	102
Compliance Forms	103
The Installation Document	104
Other Requirements	104
Section 8.2: G99 Type A, Additional Information	105
Getting Connected – Guidance on Compliance	105
Section 8.3: G99 Type B-D, The Connection Application Process	108

Introduction	108
The Connection Application Timeline	108
Initial Discussions with the DNO	110
Information about the Network	110
The Standard Application Form	110
Network Studies	111
The Connection Offer	112
Wayleaves for New Connections	112
Connection Conditions	113
Interactive Connection Applications	113
Accepting a Connection Offer	114
EREC G99 Additional Forms	114
EREC G99 Notifications	116
Section 8.4: G99 Type B-D, The Connection Application Process – Generation Licensing	118
Introduction	118
Who Requires a Generation Licence?	118
Requirements for a Generation Licence	118
Applying for a Generation Licence	119
National Energy System Operator Interfaces	119
Evaluation of Transmission Impact Assessment Process	121
Where to Find More Information	121
Getting Connected – Guidance on Compliance	122
Reactive Capability across Voltage Range	124
Section 9: G99 Costs and Charges	128
Section 9.1: G99 Type A, Costs and Charges	128
Introduction	128
Connection Charges – Infrastructure	128
Connection Charges – Other Elements	129
Use of System Charges	131
Metering Requirements, Parties and Charges	132
Section 9.2: G99 Type B-D, Costs and Charges	134
Introduction	134

Submitted by ENA to: Penny Carolan (NationalGrid). Delivered to: pcarolan@nationalgrid.co.uk on 03/04/2025 at 10:08. © ENA 2025. Unauthorised sharing or distribution is prohibited.

Connection Charges – Infrastructure.....	134
Connection Charges – Other Elements.....	135
Transmission Connection Charges	138
Where to Find More Information	139
Ongoing Charges.....	140
Section 9.3: G99 Type A & Type B-D, Costs and Charges	144
Changes to Use of System Charges	144
Section 10: Selling Electricity (Smart Export Guarantee & CFD)	147
Section 10.1: G99, Selling Electricity (Smart Export Guarantee)	147
Introduction	147
Tariff Structure	147
Eligibility and Accreditation	148
Where to Find More Information	149
Section 10.2: G99, Contracts for Difference	150
Introduction	150
Contracts for Difference (CFD)	150
Renewables Obligation.....	151
Where to Find More Information	151
Section 11: G99 Type B-D, Technical and Commercial Interfaces	152
Introduction	152
Contestable and Non-contestable Work.....	153
National Electricity Registration Scheme.....	154
Practicalities of ICP Connections	154
Contracts and Agreements	155
Operational Issues.....	156
Glossary of Terms	159
Appendix A	161
Examples showing the process for inverter sizing, determining and clarifying registered capacity	161
Installer Guidance	165

Distributed Generation Connection Guide

An Introduction to the Distributed Generation Connection Guide

Who is this Guide for?

This Guide is intended to help you, as a developer or prospective owner of Distributed Generation, to connect your generation to a distribution system in Great Britain (GB). It may also be useful for installers or manufacturers of Distributed Generation equipment.

The types of generation that most frequently connect to the distribution system include:

- renewable energy projects;
- waste to energy projects;
- energy storage projects (e.g. batteries); and
- on-site generation and Combined Heat and Power (CHP) projects.

What is the aim of the Guide?

The main aim of the Guide is to provide a 'route map' of the processes for getting generation connected to the distribution system. The Guide provides an overview of the connection process, as well as details on the application stage.

The connection process involves discussions and agreements between you and your Distribution Network Operator (DNO). Note that the term 'DNO' as used in this guide refers to both DNO and IDNO companies. This connection process is more likely to be successful if you and the DNO can communicate effectively and understand each other's concerns. So, in addition to its main aim of providing a 'route map' of the connection process, the Guide has a number of other aims:

- To provide background information about the GB power sector and the role Distributed Generation has to play;
- To describe the main factors affecting connection costs and ongoing charges;
- To highlight your options relating to your connection works, identify different contracts relating to your connection and discuss some day-to-day operational issues; and
- To describe two key financial incentives for Distributed Generation: Smart Export Guarantee (SEG) and Contracts for Difference (CFD).

What is not covered in the Guide?

In addition to arranging a connection to the network, you will also have other issues to address to get your project up and running. These include:

- Designing, installing and operating the generation installation;
- Buying and selling electricity (beyond SEGs and CFDs);
- Planning the project;
- Financing the project; and
- Resolving local planning issues.

These issues are outside the scope of this Guide, but you will need to know about these issues and progress them in parallel with the connection process.

This document covers the process for connecting generation to the distribution system in GB. Northern Ireland has different connection arrangements, for example different versions of Engineering Recommendations G98 and G99 are in use there. For more information, refer to the Northern Ireland Electricity website: [Find out more about the Distribution Code for Northern Ireland | Northern Ireland Electricity Networks](#)

The format of the Guide

This Guide has been written and formatted with you, the reader, in mind. We think this Guide will be useful for customers who already have generation, installers of generation equipment and developers of generation projects. We have tried to make this Guide as clear and easy to read as we can, bearing in mind that some of the issues discussed are technical and complex. In particular:

- Terms which may be unfamiliar are defined or explained in boxes around the main text;
- Key points and summaries are highlighted;
- Where necessary the Guide distinguishes between the arrangements that apply in Scotland and those which apply in England and Wales. These are indicated with a Scottish flag; and
- At the end of most sections there is a pointer on where to find more information.

Though this Guide is intended for the general public and it should not require the reader to have specific technical knowledge or be familiar with the energy industry, please be aware that the topics covered here are technical and complex. Where possible, terms that may be unfamiliar are explained.

Governance of the guide

This Guide is a Distribution Code Review Panel (DCRP) document. The DCRP will update the Guide using similar processes it has for updating other distribution related documents.

There are many areas of regulation and legislation relating to Distributed Generation which are evolving and a number of issues are under consultation. The Guide has tried to capture the most up to date position at the time of writing. However, for the most up to date information you should refer to key documents and organisation websites. Please see the reference section for more information.

Governance of related codes and documents

Many of the codes and other documents described in this Guide are governed in such a way that any interested and materially affected party can propose a change to them. This includes the connection and use of system charging arrangements (for both distribution and transmission charges) which are set out in the DCUSA and CUSC respectively and technical aspects that are set out in the Distribution Code and the Grid Code. There are also groups within the Distributed Generation community with DNO representation where issues can be raised and discussed which may lead to changes being proposed.

A group that discusses commercial and procedural issues associated with connection of Distributed Generation is the Distributed Energy Resource Technical Forum ([DER Technical Forum](#)). Any issues you have for this Forum should be raised through trade associations who are represented. Please note that practices between DNOs may be different; for example, where the connection requirements are location-specific, or the connection risks and the network characteristics are different.

The process of connecting Distributed Generation to the distribution system varies depending on the size of the generation to be connected, and the specific technology to be used. In general, the larger the generation capacity, the more complex the process.

The Engineering Recommendations (ERECs) that cover the connection of Distributed Generation to the distribution system are EREC G98 (for smaller generation capacities less than 16A per phase) and EREC G99 (for all other generation capacities). These are technical documents that can be available on the ENA's website here: [EREC G98](#) and [EREC G99](#).

This document, known as the Guide, is designed to explain the connection process in a clear and concise manner.

Previously this Guide was published in several sections. These separate sections have been combined into a single document which contains information applicable to all sizes of generation projects, including:

- EREC G98 compliant units in a single premises;
- EREC G98 compliant units in multiple premises within a close geographic region;

- EREC G99 Type A Power Generating Module projects; and
- EREC G99 Type B-D Power Generating Module projects.

Structure of the Guide

This document is structured as follows:

- Part 1 of this Guide consists of the sections relevant to connecting Distributed Generation that falls under EREC G98. This includes connections at single and multiple premises; and
- Part 2 of this Guide consists of the sections that are relevant to Distributed Generation that fall under EREC G99. This includes Type A and Types B – D Power Generating Modules.

Table 1 of this Guide includes a ‘quick check’ to help you find the right sections of this Guide relevant for your project type.

Where you are installing multiple asynchronous or inverter connected generating units, the application process (as described in EREC G98 or EREC G99) is based on the total installed capacity of all the generating units.

Where you are installing synchronous Power Generating Modules, the application process (as described in EREC G98 or EREC G99) is based on the capacity of each generating unit.

If you are adding new generating units to an existing installation, refer to the guidance on page 73: New and Existing Generation.

Table 1 is a summary of the criteria for different types of projects that sit under EREC G98 or EREC G99. This table allows you to find which EREC is applicable to your project, i.e. either EREC G98 or EREC G99.

This document is updated every year to include modifications to the connection process in EREC G98 and EREC G99 and wider industry updates. Please note, this version of the Guide refers to changes made to the versions of EREC G98 and EREC G99 and the Distribution Code that are currently with Ofgem for approval (with an expectation that they will be approved). These changes will only come into effect if they are approved by Ofgem. In the event that Ofgem approves the versions currently with them before the Guide is published, this statement will be updated.

Table 1: Table summarising the criteria for different types of projects

Project Type	Criteria
Connecting Distributed Generation that falls under EREC G98 in a single premises	Installation of one or more EREC G98 compliant Micro-generators at a single premises with and combined Registered Capacity no higher than 16A per phase, i.e 11.04kW three phase or 3.68kW single phase.
Connecting Distributed Generation that falls under EREC G98 in multiple premises	Installation of Micro-generators at multiple premises, where each premises includes one or more EREC G98 compliant Micro-generators with a combined Registered Capacity no higher than 16A per phase, i.e 11.04kW three phase or 3.68kW single phase.

- Distributed Generation is compliant with EREC G98 if:
- It meets the size definition of Micro-generator.
 - It is installed in accordance with EREC G98. Your installer should be familiar with these requirements; and
 - It has been tested and approved according to the relevant Type Testing Annex in EREC G98.

Connecting Type A Power Generating Modules under EREC G99	Installation of one or more Generating Units at a single premises where: <ul style="list-style-type: none"> The registered capacity of each Power Generating Module is >16 A/phase, but less than 1 MW; and The Connection Point is below 110 kV (in practice in GB this is at 66 kV or below).
Connecting Type B — D Power Generating Modules under EREC G99	Installation of one or more Generating Units at a single premises where the registered capacity of each Power Generating Module is at or above 1 MW, or where the Connection Point is at or above 110 kV (in practice in GB this is at 132 kV or above).

Once you have identified whether your project falls under EREC G98 or EREC G99, refer to Table 2 and Table 3 for projects in the scope of EREC G98 or Table 4 and Table 5 for projects in the scope of EREC G99.

Table 2: Table showing the Part 1 sections of this Guide relevant for EREC G98 projects

	Section in this Guide							
Project Type	1 & 2: Power Network Background		3: Connection Process		4: The Connection Application Process		5: Cost of Charges	6: Selling Electricity
G98 Single	1	2	3.1	3.3	4.1	4.3	5.1	6.1
G98 Multiple			3.2		4.2		5.2	

Table 3: Table showing the contents of each section within Part 1 of this Guide and the EREC G98 types of projects they are applicable to

Section:	Contents:	Applicable Project Types:
Section 1 – A Guide to the GB Power Sector	A Guide to the GB Power Sector	G98 Single & Multiple Premises
Section 2 – The Role of Distributed Generation	The Role of Distributed Generation	G98 Single & Multiple Premises
Section 3.1 – An Overview of Getting Connected	Introduction	G98 Single Premises
	Getting Connected – Main Tasks	
	Getting Connected – IDNO’s Networks	
	Getting Connected – Connect Direct	
	Getting Connected – Validity of Type Testing	
Section 3.2 – An Overview of Getting Connected	Introduction	G98 Multiple Premises
	Getting Connected – Main Tasks	
	Getting Connected – IDNO’s Networks	
	Getting Connected – Connect Direct	
	Getting Connected – Validity of Type Testing	

Section:	Contents:	Applicable Project Types:
	Customer Service and Provision of Information	
<u>Section 3.3: G98 Additional Information</u>	Getting Connected – Electricity Storage	G98 Single & Multiple Premises
	Getting Connected – EREC G98 Exceptions	
	Getting Connected – Vehicle to Grid	
	Where to Find More Information	
<u>Section 4.1: G98 Single Premises, The Connection Application Process</u>	Introduction	G98 Single Premises
	The Installation Document	
	Other Requirements	
<u>Section 4.2: G98 Multiple Premises, The Connection Application Process</u>	Introduction	G98 Multiple Premises
	The Connection Application Form	
	Installation and Commissioning	
	The Installation Document	
	Other Requirements	
<u>Section 4.3: G98 Single & Multiple Premises, Additional Information on Compliance</u>	Getting Connected – Guidance on Compliance	G98 Single & Multiple Premises
<u>Section 5.1: G98 Single Premises, Costs and Charges</u>	Use of System Charges	G98 Single Premises
<u>Section 5.2: G98 Multiple Premises, Costs and Charges</u>	Introduction	G98 Multiple Premises
	Connection Charges	
	Connection – Other Elements	
	Use of System Charges	
<u>Section 6.1 Selling Electricity</u>	Introduction	G98 Single & Multiple Premises
	Tariff Structure	
	Eligibility and Accreditation	
	Where to Find More Information	

Table 4: Table showing the Part 2 sections of this Guide relevant for EREC G99 projects

	Section in this Guide											
Project Type	1 & 2: Power Network Background		7: Connection Process			8: The Connection Application Process		9: Cost of Charges		10: Selling Electricity		11: Technical and Commercial Interfaces
G99 Type A	1	2	7.1	7.2	7.4	8.1	8.2	9.1	9.3	10.1	10.2	11
G99 Type B-D				7.3		8.3	8.4	9.2				

Table 5: Table showing the contents of each section within Part 2 of this Guide and the types of G99 projects they are applicable to

Section:	Contents:	Applicable Project Types:
Section 1 – A Guide to the GB Power Sector	A Guide to the GB Power Sector	G99 Type A & G99 Type B-D
Section 2 – The Role of Distributed Generation	The Role of Distributed Generation	G99 Type A & G99 Type B-D
Section 7.1: G99 Type A & Type B-D Power Generating Modules	Types of Power Generating Module	G99 Type A & G99 Type B-D
	New and Existing Generation	
	Customer Service and Provision of Information	
Section 7.2: G99 Type A, An Overview of Getting Connected	Introduction	G99 Type A
	Getting Connected – Main Tasks	
	Getting Connected – Validity of Type Testing	
	Getting Connected – Connect Direct	
	Getting Connected – IDNO's Networks	
Section 7.3: G99 Type B-D, An Overview of Getting Connected	Introduction	G99 Type B-D
	Connection Process Overview	
	Getting Connected – Project Planning Phase	
	Getting Connected – Information Phase	
	Getting Connected – Design Phase	
	Getting Connected – Construction Phase	
	Getting Connected – Testing and Commissioning	
	Getting Connected – Ongoing Responsibilities	

Supplied by ENA to: Penny Carolan (National Grid). Delivered to: pcarolan@nationalgrid.co.uk on 03/04/2025 at 10:08. © ENA 2025. Unauthorised sharing or distribution is prohibited.

Section:	Contents:	Applicable Project Types:
	Getting Connected – Connect Direct	
	Changes to your Power Generating Module	
	Getting Connected – Medium and Large Stations	
	Registered Capacity Definition	
Section 7.4: G99, Additional Information	Getting Connected – IDNO's Networks	G99 Type A & G99 Type B-D
	Getting Connected – Electricity Storage	
	Getting Connected – EREC G99 Exceptions	
	Getting Connected – Vehicle to Grid	
	Getting Connected – Customer Island Operation	
	Where to Find More Information	
Section 8.1: G99 Type A, The Connection Application Process	Introduction	G99 Type A
	The Standard Application Form	
	The Connection Offer	
	Compliance Forms	
	The Installation Document	
	Other Requirements	
Section 8.2: G99 Type A, Additional Information	Getting Connected – Guidance on Compliance	G99 Type A
Section 8.3: G99 Type B-D, The Connection Application Process	Introduction	G99 Types B-D
	The Connection Application Timeline	
	Initial Discussions with the DNO	
	Information about the Network	
	The Standard Application Form	
	Network Studies	
	The Connection Offer	
	Wayleaves for New Connections	
	Connection Conditions	
	Interactive Connection Applications	
	Accepting a Connection Offer	
	EREC G99 Additional Forms	
	EREC G99 Notifications	

Section:	Contents:	Applicable Project Types:
Section 8.4: G99 Type B-D, The Connection Application Process – Generation Licensing	Introduction	G99 Types B-D
	Who Requires a Generation Licence?	
	Requirements for a Generation Licence	
	Applying for a Generation Licence	
	National Energy System Operator Interfaces	
	Evaluation of Transmission Impact Assessment Process	
	Where to Find More Information	
	Getting Connected – Guidance on Compliance	
Section 9.1: Type A, Costs and Charges	Reactive Capability across Voltage Range	G99 Type A
	Introduction	
	Connection Charges - Infrastructure	
	Connection Charges – Other Elements	
	Use of System Charges	
Section 9.2: Type B-D, Cost and Charges	Metering Requirements, Parties and Charges	G99 Types B-D
	Introduction	
	Connection Charges - Infrastructure	
	Connection Charges – Other Elements	
	Transmission Connection Charges	
	Where to Find More Information	
Section 9.3: Type A & Type B-D, Cost and Charges	Ongoing Charges - Introduction	G99 Type A & G99 Type B-D
	Changes to Use of System Charges	
Section 10.1: G99, Selling Electricity (Small Export Guarantee)	Introduction	G99 Type A & G99 Types B-D
	Tariff Structure	
	Eligibility and Accreditation	
	Where to Find More Information	
Section 10.2: G99, Contracts for Difference	Introduction	G99 Type A & G99 Types B-D
	Contracts for Difference (CFD)	
	Renewables Obligation	
	Where to Find More Information	
Section 10.3: G99, Other Matters	Introduction	G99 Types B-D

Section:	Contents:	Applicable Project Types:
Section 11: G99 Type B-D, Technical and Commercial Interfaces	Contestable and Non-contestable Work	
	National Electricity Registration Scheme	
	Practicalities of ICP Connections	
	Contracts and Agreements - Introduction	
	Operational Issues - Introduction	

Additional information

The following information boxes provide useful information to relating to the content in this document.

Engineering Recommendation G98

EREC G98 is called “Requirements for the connection of Fully Type Tested Micro-generators (up to and including 16 A per phase) in parallel with public Low Voltage Distribution Networks”. It sets out the requirements you must meet before your Micro-generator can be connected to the network. The capacity threshold refers to the aggregate generating capacity installed in a single premises. EREC G98 is available on the Distribution Code website [here](#).

The document is aimed at the manufacturers and installers of your Micro-generator.

Engineering Recommendation G99

EREC G99 is called “Requirements for the connection of generation equipment in parallel with public distribution systems”. The purpose of the document is to provide guidance to you and to DNOs on all aspects of the connection process. It contains a glossary of items and diagrams of Power Generating Module types and categorisation, which you may find helpful. EREC G99 is available on the Distribution Code website [here](#).

Micro-generator

A Micro-generator is defined in EREC G98 as “A source of electrical energy and all associated interface equipment able to be connected to an electric circuit in a Low Voltage electrical installation and designed to operate in parallel with a public Low Voltage Distribution Network with nominal currents up to and including 16A per phase. For the avoidance of doubt this includes electricity storage devices”.

16 A per phase corresponds to 3.68 kW on a single-phase low voltage supply and 11.04 kW on a three-phase low voltage supply and refers to the aggregate Micro-generator capacity installed in a single premises.

Close Geographic Region

Close Geographic Region is defined in EREC G98. Typically, a close geographic region is one which is fed by the same part of the distribution system, from a single feeder or distribution transformer. Your DNO will be able to advise you if your Micro-generators are within a close geographic region. A general rule of thumb is that if your Micro-generators are within 500 metres of each other, or if the post codes are the same at least up until the last two letters, then they are likely to be within a close geographic region.

Inverters

An inverter is an electrical device that converts Direct Current (DC) to Alternating Current (AC). An inverter is required if you want to connect a generating unit with a DC output (eg. A Photovoltaic array) to the distribution system, which operates at AC. The term Micro-Inverter is used to describe inverters which are connected to (one or more) small generating units, such as individual PV panels. This is often done so that if one PV panel is impaired for any reason, then the output of the others is not affected.

Type tested equipment

Type tested equipment is defined in EREC G99 as “A product which has been tested to ensure that the design meets the relevant requirements of this EREC G99, and for which the Manufacturer has declared that all similar products supplied will be constructed to the same standards and will have the same performance”.

Examples of products which could be type tested include generating units, inverters and the interface protection. Using type tested equipment simplifies the connection and commissioning process. Annexes in EREC G98 and EREC G99 contain methodologies for testing equipment against a set of test conditions to demonstrate compliance. If a manufacturer follows these methodologies, they may produce a Type Test Verification Report to demonstrate compliance. Where the whole Micro-generator or Power Generating Module is Type Tested (rather than just part of it), it is considered to be Fully Type Tested. All Micro-generators connecting under EREC G98 must be Fully Type Tested. The Fully Type Tested concept also applies in EREC G99.

The ENA has replaced the Type Test Register which closed on the 16th April 2024. As a result, all functionality and all held data has been migrated across to the [Connect Direct Portal](#). On Connect Direct, you are now able to register new devices, update existing devices and register new users / manufacturers. Using Connect Direct allows products to be registered with the ENA to then be assessed and make them available to installers submitting domestic connection applications, therefore making the process more automated. This register is provided to allow anyone access to the Type Test Verification reports for products relating to electricity generation that may be connected to the distribution system in the UK.

The portal also includes System Reference numbers against each product.

The product manufacturer is responsible for uploading and maintaining data and documentation relating to their products. The ENA reviews the data that is submitted and raises any queries with the manufacturer.

It should be noted that it is the owner of generation equipment who is responsible for procuring and installing compliant equipment.

There has been a recognition that there is a need to provide more clarity on the validity of existing Type-Testing equipment following a new change and requirement in EREC G98 and EREC G99. Some changes and/or additions to EREC G98 may invalidate newly manufactured Micro-generator's Fully Type Tested status and will require manufacturers who had previously certified devices as being compliant to go through the ENA assessment process again. Manufacturers will need to submit updated certifications for devices so that they can be reassessed before they can be considered to be Fully Type Tested against the revised EREC G98 requirements and hence be suitable for installation on or after the date the revised requirement becomes operative. The same applies to EREC G99.

Minor revisions to EREC G98 and EREC G99, such as clarifications, which do not change the underlying technical requirements, will be issued as formal amendments to the existing version of the EREC, and will not need manufacturers to repeat testing nor submit their devices to the ENA for reassessment.

Changes to EREC G98 and EREC G99 which do change the underlying technical requirements, will be issued as formal amendments to the existing version of the EREC, and will need manufacturers to repeat testing and submit their devices to the ENA for reassessment.

All Micro-generators connected to the DNOs network shall be Fully Type Tested in accordance with EREC G98, unless the DNO agrees it is impractical, for example, where a Power Generating Module is being designed specifically for that location, such as is sometimes appropriate for micro hydro installations.

Cyber Security

The design and operation of your generating unit, the Power Generating Facility and any associated equipment should comply with current cyber security requirements. Documents that you should consider are detailed in EREC G98 and EREC G99 as well as the Reference Section of this Guide.

Equipment Certification

Potential Equipment Certificate providers and manufacturers are investigating formal equipment certification arrangements. The ENA is supporting these developments as appropriate.

Emerging Technology

EREC G98 and EREC G99 have a relaxed set of requirements for generation that is classified as an Emerging Technology. The Emerging Technology status only applies to Type A Power Generating Modules, which have a generating capacity of 0.8 kW to 1 MW and where the Connection Point is below 110 kV (in practice in GB this is at 66 kV or below). The Emerging Technologies are:

- Baxi Ecogen' generators (the specific products are the Baxi Ecogen 24/1.0, Baxi Ecogen 24/1.0 LPG and Baxi Ecogen System);
- KD Navien Stirling engine m-CHP (Hybrigen SE) (the specific products are the 'NCM- 1130HH – 1 kWel' and the 'NCM-2030HH – 2 kWel');
- Pellematic Smart_e; and
- Dachs Stirling SE Erdgas and Dachs Stirling SE Flussiggas.

Requirements for Generators (RfG) Types A to D

The EU Network Code Requirements for Generators (RfG) introduced the classification of Power Generating Modules by Types. There are four types, A to D, and they relate to the registered capacity and connection voltage of the Power Generating Module. In GB, the Types are:

- Type A: Registered capacity from 0.8 kW to < 1 MW and connected at < 110 kV;
- Type B: Registered capacity from 1 MW to < 10 MW and connected at < 110 kV;
- Type C: Registered capacity from 10 MW to < 50 MW and connected at < 110 kV; and
- Type D: Registered capacity ≥ 50 MW or connected at ≥ 110 kV.

Note that in different European countries, the capacity and voltage thresholds for the Types may differ.

The technical requirements in RfG are less onerous for smaller Power Generating Modules, and they increase cumulatively for the larger Power Generating Modules, for example a Type B Power Generating Module must meet the requirements for Type A and Type B Power Generating Modules. Some requirements are common across all European countries. However, some requirements have country-specific parameters, which have been set by national network operators. That means that some of the parameters in GB are different in Northern Ireland, and other European countries. For more information on RfG, refer to the 'Current Regulations' section below.

Current Regulations

Requirements for Generators

The European Third Energy Package was adopted in July 2009 and has been law since March 2011. The Third Energy Package refers to a suite of legislation for both Electricity and Gas. It had three key objectives:

1. Enhancing sustainability and helping the European Union meet its decarbonisation obligations;
2. Ensuring security of supply in light of a changing generation mix; and
3. Creating a single European Market for Electricity.

The Third Energy Package required the development of European Network Codes. The Network Codes cover three areas: grid connection codes, market codes and system operation codes. One of the grid connection codes is called Requirements for Generators (RfG). The RfG sets out requirements which new generators need to meet.

The RfG, which became a binding EU regulation in May 2016, is available on the [EUR-Lex website](#). A number of the EU Network Codes, including the RfG fall under the category of retained EU law and thus remain applicable to the UK following the UK's withdrawal from the European Union.

A joint Distribution Code Review Panel (DCRP) and Grid Code Review Panel (GCRP) workgroup was charged with implementing the Requirements for Generators code in GB. This included setting parameters that the RfG leaves to national interpretation. The workgroup proposed changes to the Grid Code, Distribution Code and supporting Engineering Recommendations. The revised documents were consulted upon with stakeholders by the GCRP and the DCRP.

Drivers for the Requirements for Generators

The EU Network Codes aim to harmonise technical and market rules to help to minimise barriers to energy trading. They also aim to prevent wide-scale technical events, and to help to recover the electricity system if there is such an event in the future. There has been a huge increase in the amount of generation connected to the distribution system in GB and across Europe. It has been recognised that Distributed Generation can and needs to do more to provide support to the power system, so that, for example, Distributed Generation supports system frequency, remains connected if possible and rides through faults – rather than tripping off and potentially exacerbating any problems.

The Requirements for Generators contains technical requirements, which have been incorporated into EREC G98 and EREC G99, so that generating units can provide such system support. For example, there are requirements for:

- All Type B, C and D Power Generating Modules to stay connected to the distribution system when there is a fault on the transmission system;
- Type B, C and D inverter connected Power Generating Modules (eg solar PV, battery storage, wind turbines) to provide support in the event of a network fault, using a technique called Fast Fault Current Injection (the design of synchronous machines means they inherently provide support during faults);
- All Power Generating Modules to provide support in the event of a high frequency event (Limited Frequency Sensitive Mode – Over frequency); and

- Type C and D Power Generating Modules to provide support for low frequency events (Limited Frequency Sensitive Mode – Underfrequency).

These requirements have been introduced so that generation of all sizes can help to provide system support. The rules apply to all generation whether connected to the transmission system or the distribution system.

Electricity Storage

Electricity storage is classed in GB law as being a form of generation. The technical and compliance requirements for storage were revised in EREC G98 and EREC G99 to be in line with other types of generating units and came into effect from September 2022. All electricity storage devices commissioned after September 2022 need to be fully compliant with EREC G98 or EREC G99 as appropriate. There has since been a further update and all electricity storage devices installed after January 2026, when operating in import mode, need to switch to export mode if the grid frequency falls below a defined threshold. For more information on this new requirement, please refer to the following clauses in the EREC documents relevant to your generation project.

- Clauses 9.4.3 and 9.4.4 in EREC G98; and
- Clauses 11.2.3.3, 12.2.3.3 and 13.2.5.2 in EREC G99.

New Approach to Facilitate Connections

Information about the process for connecting to networks can be found on the ENA's website located [here](#). The webpage has recently been updated and contains important information which can assist customers seeking to connect Distributed Generation to the distribution system.

In response to the need to improve and accelerate customer connections the ENA has been working with the DNOs and Ofgem to determine appropriate connection reforms needed to accelerate grid connections, reduce the connection queues, and keep the industry on track with the energy transition goals. As a result, the ENA developed an [Action Plan](#), describing the required changes needed to improve connections to the distribution system.

The UK Government announced in December 2024 their Clean Power 2030 strategy, which requires an even greater focus on connection reforms to ensure 100% clean electricity generation across the GB network can be realised in a timely manner. Further information on queue management is on [NESO's website](#).

As such, and in line with the Clean Power 2030 strategy, there is a need too:

- Strengthen and tighten the application process;
- Release capacity by cleaning up the connections queue;
- Accelerate more grid applications; and
- Further improve coordination between transmission and distribution operators.

Ofgem is undertaking a review of connection reforms. This is an ongoing discussion, and readers should refer to Ofgem and ENA announcements throughout.

The ENA has launched [Connect Direct](#) as a single integrated portal to help and streamline the application process for the installation of low carbon technologies with its primary users being installers. Connect Direct was introduced to automate the connection process. This will reduce the amount of information an installer needs to provide and uses machine-to-machine communication to speed up the application process.

Please note that Connect Direct is aimed at connecting smaller devices installed in domestic premises. The portal is being continuously developed but for the time being, more complex connection applications should follow the legacy application process. Micro-generators who have the option to use Connect Direct can also make use of the paper-based connection application process.

Where an applicant is looking to do multiple installations in the same geographic area, they need to make use of paper based G98 forms or can make multiple applications via the Connect Direct Application Programming Interface (API).

Generation Sharing Devices

Generation sharing devices have been installed in several customers premises in GB. In order to clarify the connection arrangements and simplify the connection process there is a need to include requirements in EREC G99 associated with generation sharing devices in order to make sure that these systems are designed and operated safely. These sharing devices allow generation, typically solar PV generation, to provide electricity to two or more independent customers connected at low voltage, for example, to customers living in a block of flats. The generation and sharing devices are typically owned by a third party, such as the landlord of the block of flats or the building network operator. The electricity produced by the generation is shared between two or more customers living in the building.

Key points to note:

- Generation sharing is only permitted where the generation and sharing device and all properties supplied from it are supplied by a single LV feeder equipped with standard LV protection arrangements.
- Multiple generation sharing devices in one building are allowed (ie to service more properties than a single generation sharing device is designed for), subject to all requirements in EREC G99 being met.
- In general, all properties connected to an individual generation sharing device should be supplied from the same DNO connection point, and be within the same physical building.

Any intended variations from these requirements must be specifically agreed with the DNO.

In addition, each service to each property must be supplied via a separate service cable from the same facility distribution board. Looped services are not suitable for generation sharing arrangements.

Further information on the requirements for generation sharing devices are described in EREC G99 Clause 7.8.5.12. Applications for the installation of generation sharing devices should be made on form [EREC G99 A1.1](#). However, applications will be made using Form A1.3 when it is published.

Key terms in EREC G98 and EREC G99

The key terms are summarised on this page, and some are explained further in break out boxes throughout the document or in the main text. Terms that are particularly relevant for EREC G98 are indicated with a *.

Table 6: Shows the key terms and their definitions.

Fully Type Tested*	The whole Micro-generator / Power Generating Module is type tested, rather than just part of the Micro-generator / Power Generating Module.
Micro-generator*	A source of electrical energy and all associated interface equipment connected at Low Voltage to the distribution system, with nominal currents up to and including 16 A per phase. A Micro-generator is a type of Generating Unit.
Micro-generating Plant*	An electrical installation with one or more Micro-generators with nominal currents in sum not exceeding 16 A per phase.
Generating Unit	Any apparatus that produces electricity.
Power Generating Module (PGM)	Either a Synchronous Power Generating Module (SPGM) or a Power Park Module (PPM) - see below.
Synchronous Power Generating Module (SPGM)	An indivisible set of Generating Units—ie one or more units which cannot operate independently of each other—which generate electrical energy in synchronism.

Power Park Module (PPM)	Generating Units that are connected to the network either through power electronics (eg solar PV or electricity storage devices connected through an inverter) or asynchronously (eg some wind turbines are induction or asynchronous generation). They have a single Connection Point to the distribution system.
Power Generating Facility (PGF)	One or more Power Generating Modules connected to at one or more Connection Points.
Registered Capacity	The normal maximum Active Power capacity of a Power Generating Module less the MW consumed when producing the same (ie auxiliary load). For Power Generating Modules connected via an Inverter, the lesser of the Inverter rating or the rating of the energy source is the Power Generating Module's rating.
Type A / B / C / D	Classifications of Power Generating Modules by size and connection voltage, to determine technical and compliance requirements.
Generation Sharing Device	A device that allows generation, typically solar PV, to provide electricity to two or more independent customers' properties connected at low voltage.

Section 1: A Guide to the GB Power Sector

This section provides:

- An overview of the commercial structure of the power sector;
- An introduction to the UK power sector and how it is changing;
- A discussion about the various types of organisations that you may come across while developing your Distributed Generation project;
- A discussion on network innovation projects; and
- Guidance on where to find more information.

Tip: Read the information boxes for definitions or explanations of terms that may be new or unfamiliar.

Introduction

Understanding the GB power sector may be useful when discussing your Distributed Generation project. This section gives some background explanation about the GB power sector and how it is changing to meet the challenges of protecting the environment and changing Government policy.

There are many organisations involved in the GB power sector; these are introduced in this section.

Apart from the physical structure of the power sector, there is also a commercial structure, which is discussed in this section.

The Commercial Structure of the Power Sector

The commercial structure of the electricity industry in GB provides a competitive market in electricity retailing. This enables customers to contract with any one of a number of competing electricity suppliers. The sale of energy is also a competitive market. Note, for an older generation project, a Feed-In Tariff level is an indication of the minimum you can expect to be paid for the electricity you generate.

Generators sell the electricity that they generate in the wholesale market or directly to suppliers. Suppliers sell the electricity they purchase to customers. The majority of trading occurs in advance of the time of use. The wholesale market is governed by British Electricity Trading Transmission Arrangements (BETTA), which was introduced in 2005.

If you install Distributed Generation, you can use the electricity you produce on site to reduce the amount of electricity that you need to buy thus lowering your electricity bills.

You can also sell electricity to customers, suppliers or, depending on the size of the generation, on the wholesale market. You can read more about power trade options in [Section 6 – Selling Electricity \(Smart Export Guarantee\)](#) or [Section 10: Selling Electricity](#).

The Physical Infrastructure of the Power Sector

The GB power network in the 20th century was primarily based on centralised, fossil-fuel based electricity generation. In the 21st century, there has been a shift towards decentralised, distributed and 'greener' energy source-based generation. This is a shift primarily due to targets set out by the UK government, aiming to achieve net-zero greenhouse gas emissions by 2050. This is because of the 2015 Paris climate change agreement in which governments collectively agreed to take actions to reduce global temperature increases to 1.5°C above pre-industrial levels.

Figure 1 below illustrates the current physical infrastructure of the present-day GB power sector.

Figure 1: The current physical infrastructure of the power sector.

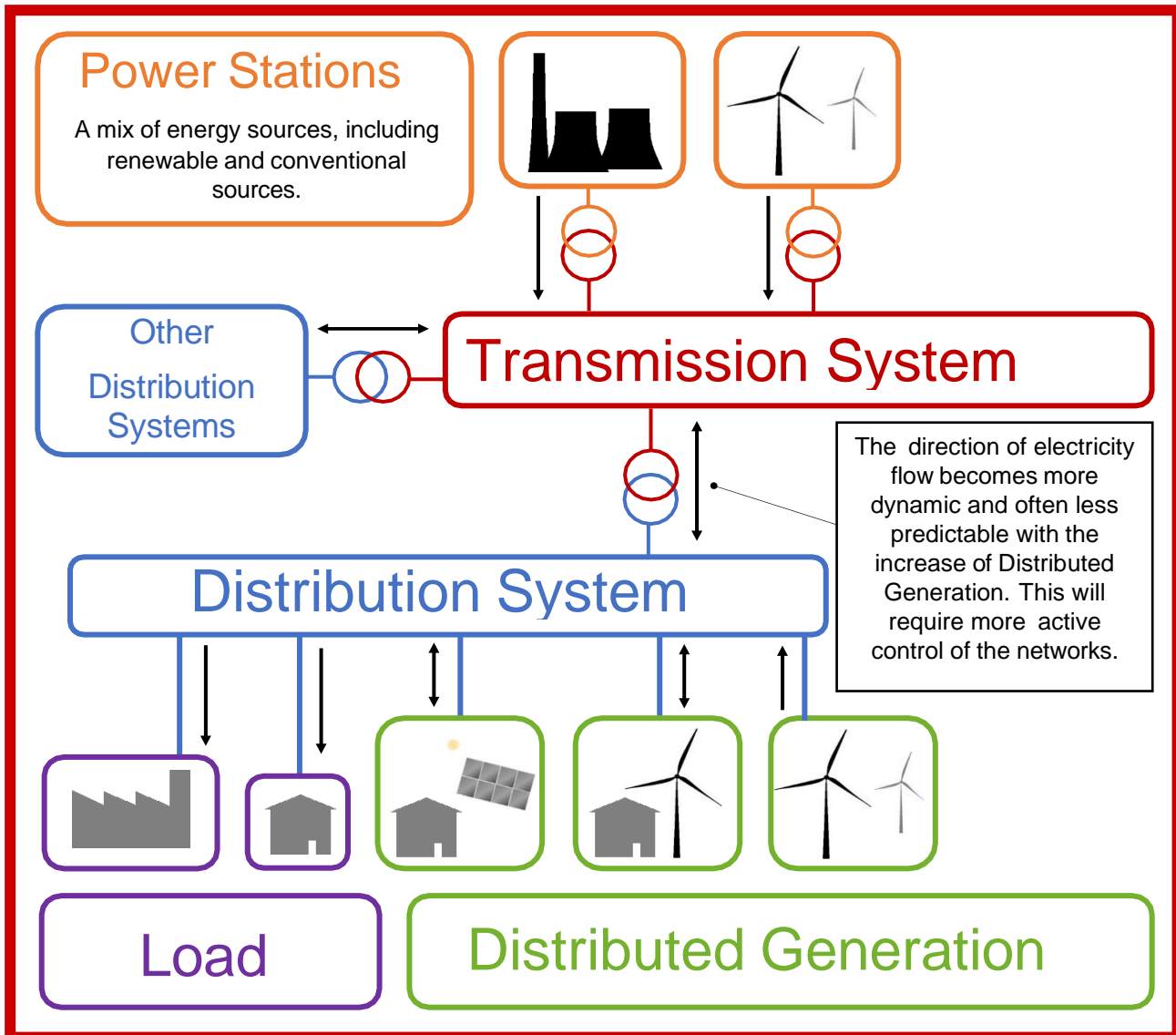

The distribution system has evolved to accommodate more advanced technologies and sources of generation. Generation plant connecting to the distribution system are termed Distributed Generation as they are distributed across the network. Distributed Generation impact the traditional flow of power which used to be in one direction and is now bi-directional. The kind of Distributed Generations that are becoming increasingly connected to the distribution network are:

- Rooftop Solar Photovoltaic (PV);
- Wind generating units; and
- Energy storage systems.

Submitted by ENA to Penny Carolan (National Grid). Delivered to Penny Carolan (National Grid) on 03/04/2025 at 10:08. © ENA 2025. Unauthorised sharing or distribution is prohibited.

Key Organisations

The transmission and distribution system is predominantly owned and operated by regulated monopoly businesses. Such transmission and distribution businesses recover the costs of operating and maintaining their systems by levying Use of System charges on electricity traded using their network.

Distribution Network Operator (DNO)

A DNO owns, operates and maintains the public electricity distribution system in one or more regions in GB. They hold a Distribution Network Operator Licence. Under the terms of their licence, each DNO is allowed to distribute electricity both inside and outside its legacy geographic area.

There are six DNOs in GB. The regions where they traditionally operate are shown on the map below in Figure 2.

Figure 2 Map of DNO regions in GB and Northern Ireland.

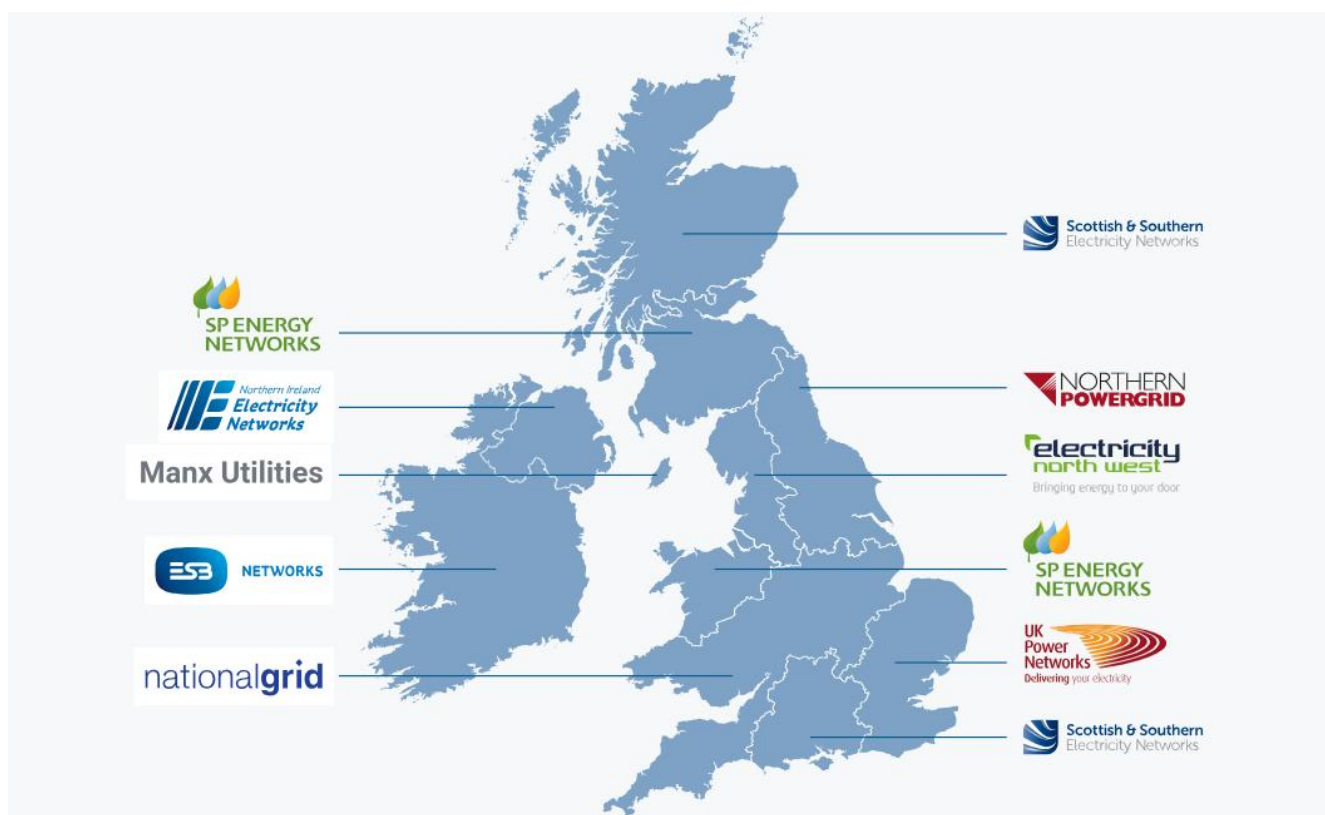

To facilitate competition in supply, each DNO is required to allow any licensed supplier to use its distribution system to transfer electricity from the transmission system (and from Distributed Generation) to customers. DNOs charge suppliers for using the distribution system.

To develop the future electricity network DNOs are becoming Distribution System Operators (DSO). This will enable them to actively manage their networks and actively engage with customers to realise the benefits that flexible demand, generation and storage can have on the distribution system reducing the need for reinforcement.

DNOs can form part of a group that undertakes other areas of business as well, eg. electricity supply. However, those businesses have to be kept separate and you will have to interface with the network operator part of the business.

Independent Distribution Network Operators (IDNOs)

An IDNO designs, builds, owns and operates a distribution system, which is an extension of an existing DNO distribution system. They typically build network for new developments such as business parks and residential areas. IDNOs differ from DNOs in that:

- they do not have service areas (they are not tied to a geographical location); and
- whilst they are regulated like DNOs, they have fewer licence conditions to meet.

If you are connecting your Distributed Generation to an IDNO's distribution system, the process is almost identical to that for connecting to a DNO's network. There are a few exceptions to this, these are discussed in [Section 3](#) and [Section 7](#) for EREC G98 and EREC G99 connections respectively.

Transmission Owner (TO)

A Transmission Owner owns and maintains the extra high voltage transmission system, known as the National Electricity Transmission System, referred to in this Guide as the transmission system. Transmission Owners are responsible for making sure that transmission services are available to the National Energy System Operator (NESO) (see explanation later in this section). The onshore Transmission Owners are as follows:

- National Grid Electricity Transmission (NGET) in England and Wales;
- SP Energy Networks (SP Transmission plc) in Central and Southern Scotland; and
- Scottish and Southern Electricity Networks (Scottish Hydro Electric Transmission plc) in Northern Scotland.

Private Networks

Private networks are extensions of an DNO distribution system which are not owned by the DNO itself. The owners of private networks are distinct from an DNO because they do not need to be licenced and are unregulated. For example, private networks can be owned by hospitals, airports, industrial sites, etc. This Guide is not intended to address connections to private networks. If you are connected to a private network, you should discuss your plans with the network owner as soon as possible.

Suppliers

Supply is the retail of electricity. Suppliers buy electricity in bulk from generators, and then sell to consumers. They are responsible for providing bills and customer services and arranging metering and meter reading. Electricity supply is a competitive market so you can choose and change your electricity supplier.

Aggregators

Aggregators specialise in co-ordinating demand and generation (including storage) to provide demand response and other market services. Network Operators and Suppliers may buy demand response and other grid balancing services from aggregators.

Energy Service Company (ESCO)

A Government paper defines ESCOs as "a company that provides a customer with energy solutions" rather than simply being an electricity or gas supplier. ESCOs can enter into long-term contracts to provide information, installation, finance, operation and maintenance. There are various models the ESCO can take. ESCOs can work on a performance contract, where they guarantee energy savings and make charges based on the extent to which these savings are achieved. This model is typically used by commercial and industrial customers. ESCOs can also work for communities, servicing a group of customers in the same local area. ESCOs may develop into a household model, to provide energy efficiency savings and small scale generation for home owners, rather than just supplying electricity.

Generators

Generators own, operate and maintain Power Generating Facilities which generate electricity from various energy sources, e.g. coal, gas, hydro and nuclear. Newer generation technologies include wind, solar, tidal and wave. See the end of this section for links to more information on generating technologies.

To identify your DNO or IDNO

If you already have an electricity meter at your site, find the first two digits of your **MPAN** (Meter Point Administration Number), which is shown on your electricity bill, and may be shown on your meter.

This corresponds to your DNO or IDNO, see Table 7 below over the page.

If you do not have an electricity meter at your site, you can contact the DNO whose geographic area you believe you are in and they will be able to confirm the network operator in your area. Or alternatively, visit the ENA website [here](#).

Figure 3: showing an example of MPAN, with first two digits indicated

Example MPAN, with first two digits indicated			
S	00	111	222
	13	1234 5678	345

First 2 MPAN digits	Service Area	Distribution Business
10	Eastern England	UK Power Networks– Eastern England
11	East Midlands	National Grid Electricity Distribution (NGED) – East Midlands
12	London	UK Power Networks (UKPN) – London Power Networks (LPN)
13	Cheshire, Merseyside and North Wales	SP Energy Networks – Cheshire, Merseyside and North Wales
14	West Midlands	National Grid Electricity Distribution (NGED) – West Midlands
15	North Eastern England	Northern Powergrid (NPg)
16	North Western England	Electricity North West Limited (ENWL)
17	Northern Scotland	SSE Power Distribution – Scottish Hydro Electric Power Distribution
18	Southern Scotland	SP Energy Networks
19	South Eastern England	UK Power Networks (UKPN) – South Eastern Power Networks (SPN)
20	Southern England	SSE Power Distribution – Southern Electric Power Distribution
21	Southern Wales	National Grid Electricity Distribution (NGED) – South Wales
22	South Western England	National Grid Electricity Distribution (NGED) – South West
23	Yorkshire	Northern Powergrid (NPg)
24	No area—IDNO	GTC (Independent Power Networks)
25	No area—IDNO	ESP Energy Limited
26	No area—IDNO	Last Mile Electricity Limited
27	No area—IDNO	GTC (The Electricity Network Company Limited)
28	No area—IDNO	UK Power Networks (IDNO) Ltd
29	No area—IDNO	Harlaxton Energy Networks Limited
30	No area—IDNO	Leep Electricity Network Limited
31	No area—IDNO	UK Power Distribution Limited
32	No area—IDNO	Energy Assets Networks Limited
33	No area—IDNO	Eclipse Power Limited
34	No area—IDNO	Murphy Power Distribution Limited
35	No area—IDNO	Fulcrum Electricity Assets Limited
36	No area—IDNO	Vattenfall Network Limited
37	No area—IDNO	Forbury Assets Limited
38	No area—IDNO	Indigo Power Limited
39	No area—IDNO	Squire Energy Metering Limited
40	No area—IDNO	Utility Assets Limited
42	No area—IDNO	Advanced Electricity Networks

Submitted by ENA to: Penny Carolan (National Grid). Delivered to: penny.carolan@nationalgrid.co.uk on 03/04/2025 at 10:08. © ENA 2025. Unauthorised sharing or distribution is prohibited.

43	No area—IDNO	IDCS Ltd
----	--------------	----------

Table 7: Table showing the relevant Distribution Business.

National Energy System Operator (NESO)

Electricity cannot be stored at a large scale and so demand has to be balanced with generation on a second-by-second basis by an Electricity System Operator. In GB the Electricity System Operator is the National Energy System Operator, NESO. NESO makes requests of generators to increase or decrease output from their generating units or may ask some large customers to control their demand.

Previously the Electricity System Operator role was owned by the National Grid Group through a legally separate company known as the National Grid Electricity System Operator (NGESO). From the 1st October 2024, the UK Government established an independent System Operator as a publicly owned organisation, leading to the creation of NESO.

Further information can be found on [NESO's website](#).

Balancing Settlement Code company

Elexon is the company that manages the balancing and settlement of electricity trading. They do this by identifying where generators have not generated the amount of electricity they are contracted to produce, and suppliers' customers have not consumed the amount of electricity that was expected. Out of balance parties are charged based on the additional cost to balance supply and demand (often by buying or selling electricity at short notice).

The Balancing and Settlement Code (BSC) governs the operation of this balancing mechanism.

Regulator

The Office of Gas and Electricity Markets (Ofgem) is responsible for:

- regulating prices and performance in the monopoly elements of the electricity supply industry;
- resolving disputes between different parties when necessary; and
- granting licences for the following activities in the power sector:
 - Generation;
 - Transmission (and interconnection, a transmission link with another country);
 - Distribution; and
 - Supply.

Generation licence requirements for Distributed Generation are discussed in Part 2 of this Guide.

European organisations

The regulatory arrangements that apply across continental Europe are implemented by National Regulator Authorities (NRA) in each member state of the European Union; Ofgem is the National Regulatory Authority for GB. The regulations are required to comply with policy criteria determined by the European Parliament and implemented through European Directives and Regulations. To assist with this process in relation to electricity networks, a number of bodies have been set up that represent regulators and transmission system operators. National Energy Regulators work with the Agency for the Cooperation of Energy Regulators (ACER) and the Council of European Energy Regulators (CEER) on policy developments in different areas of electricity market liberalisation.

ENTSO-E, the European Network of Transmission System Operators for Electricity, is a membership body for Transmission System Operators (TSO). ENTSO-E promotes cooperation across Europe's TSOs. One of ENTSO-E's roles is drafting the European Network Codes, which includes the Requirements for Generators (RfG).

Submitted by ENA to: Penny Carolan (National Grid). Delivered to: pcarolan@nationalgrid.co.uk on 03/04/2025 at 10:08. © ENA 2025. Unauthorised sharing or distribution is prohibited.

Following the UK's withdrawal from the European Union, GB is no longer a member of ENTSO-E. However, a number of the European Network Codes, including the RfG, fall under the category of retained EU law and thus remain applicable to GB following the UK's withdrawal from the European Union.

Network Innovation and Industry Developments

Innovation Funding

New challenges and applications in energy networks have motivated many projects that aim to develop innovative tools and products to improve the way networks operate and customers are connected.

Ofgem has a number of mechanisms that the DNOs and other organisations can use to fund electricity network innovation. The two main mechanisms for network companies are called the Network Innovation Allowance (NIA) and Strategic Innovation Fund (SIF), which apply to both electricity and gas distribution and transmission.

- NIA is an allowance each network company receives to fund smaller scale innovation projects which have the potential to deliver benefits to network customers.
- SIF is a competitive arrangement, where network companies compete for funding for development and demonstration of network innovations such as new technologies or novel operating and commercial arrangements.

Learning from electricity-based projects funded by these arrangements is shared amongst all DNOs and TOs for the benefit of the power sector as a whole. Incorporation of the learning into business-as-usual practices is laid out in the business plans of the individual network companies.

For more information, and details about individual projects, refer to the Smarter Networks Portal, hosted by the Energy Networks Association: [ENA Innovation Portal](#).

Electricity Network Innovation Strategy

Following a review of the NIA and SIF, Ofgem proposed a number of changes to the innovation funding schemes. One of these was the requirement on network companies to collaboratively produce an industry wide innovation strategy. The Electricity Network Innovation Strategy sets out a jointly agreed roadmap which demonstrates how innovation can accommodate future whole-system requirements and lead to benefits. The document was first published on 29th March 2018 and a new update on the innovation strategy can be found on the [ENA website](#). The next review will be in 2025.

Transmission and Distribution Interfaces

There has been a significant increase in the amount of connected Distributed Generation in the last few years. This has meant that the DNOs, TOs and the NESO have to change the way they work together, to maintain an economic and secure network. In order to address these challenges, the Transmission Distribution Interface (TDI) Steering Group was established by ENA and its members. Network companies recognise the need for distribution and transmission companies to work together more closely in order to consider how they can tackle the whole system impact of Distributed Generation including technologies such as storage.

ENA Open Networks

In January 2017 the Open Networks Project was launched by the ENA and finished in 2022. The aim of the Open Networks Project was to transform the way electricity networks operate and provide the first steps towards creating a smart grid.

The goal of the Open Networks Project was to expand the UK's local energy flexibility market so the UK energy sector can make the most of the electricity grid while bringing people and businesses along on the net zero journey. Driven by the Government's [Smart Systems and Flexibility Plan](#), the project was instrumental in informing the transition to Distribution System Operation (DSO) and establishing the UK as the world leader in the development of local flexibility markets. For further information visit the [ENA webpage](#).

The Open Networks Project had a strong focus on increasing participation and volume in the local flexibility market while increasing transparency of network planning and decision-making and making electricity network planning more coordinated and aligned.

For further information, refer to the [ENA website](#).

New technologies

From April 1, 2023, the new approach to providing network connections requires DNOs to consider offering Curtailable Connections with interim non-firm access arrangements to enable generation or demand projects to be connected to the distribution system more quickly. This was the result of Ofgem's [Access SCR decision](#). This builds on the use of Active Network Management (ANM) schemes, which were trialed in innovation projects and are being included as part of Business-as-Usual connection offers. ANM uses control systems to manage Distributed Generation in constrained areas. Note that connections subject to ANM may only be available in selected parts of the network. Export and Import limiting devices, installed by generation and demand customers respectively are also coming into use. These devices allow a limit to be set above which the generation will not export / a demand customer will not be able to import.

Export and import limiting schemes need to be compliant with EREC G100 which provides technical guidance on the technical requirements and use of Customer Export and Import Limiting Schemes. This is available at: [ENA G100 Requirements](#).

Note that previously the EREC G100 schemes required for the small generation installation procedures in EREC G99 did not need to be Fully Typed Tested. Following revisions to EREC G99 such EREC G100 devices need to be Fully Type Tested.

Where to Find More Information

There are some very good guides to the GB power sector available in the public domain. In particular, if you want to read more on this subject, you may wish to read the following:

- [A Guide: Sale of Power Opportunities for Distributed Generators](#);
- Guidance Note – The Electricity Trading Arrangements: A beginner's guide; Elexon <https://www.elexon.co.uk/knowledgebase/about-the-bsc/>

A good source of information on the organisations we have introduced are their own websites:

- Energy Networks Association —the industry body for UK energy transmission and distribution licence holders and operators: [Energy Networks Association \(ENA\) - The voice of the networks](#)
- A list of IDNOs can be found on the Ofgem website: <https://www.ofgem.gov.uk/publications/list-all-electricity-licensees-including-suppliers>
- Ofgem—The Regulator: [Welcome to Ofgem | Ofgem](#)
- National Grid Electricity Transmission (NGET) — Transmission Owner in England and Wales: <https://www.nationalgrid.com/electricity-transmission/>
- SP Energy Networks (SP Transmission plc) – Transmission Owner in Central and Southern Scotland: https://www.spenergynetworks.co.uk/pages/our_transmission_network.aspx
- Scottish and Southern Electricity Networks (Scottish Hydro Electric Transmission plc) – Transmission Owner in Northern Scotland: <https://www.ssen-transmission.co.uk/>
- National Energy System Operator (NESO) – System Operator for GB: <https://www.neso.energy/>
- Elexon—The Balancing and Settlement Code Company: <https://www.elexon.co.uk/>

For more information on ESCOs, the following document is a useful reference:

- Making ESCOs Work: Guidance and Advice on Setting Up and Delivering an ESCO; London Energy Partnership, which is on the London Energy Partnership website: <https://khub.net/>

The following website gives more information on generation technologies:

- Energy Saving Trust: <https://energysavingtrust.org.uk/>

The GB Distribution Code, Annex 1 and Annex 2 documents and the associated GB Distribution Code User Guide can be found in the link below:

- DCode: [Annexes](#)

The GB Grid Code and the associated Guide can be found in the link below:

- GCode: [Grid Code \(GC\) | National Energy System Operator](#)

Information about licence exceptions and private networks can be found:

- UK legislation: <https://www.legislation.gov.uk/ukxi/2001/3270/contents/made>

Section 2: The Role of Distributed Generation

In this section provides:

- An introduction to the role of Distributed Generation;
- A discussion on the drivers for Distributed Generation;
- Some of the benefits and impacts of Distributed Generation; and
- References to some documents where you can find out more on these issues.

Introduction

Distributed Generation is generation that is connected to and operates in parallel with the distribution system such as roof-top solar and battery storage systems. The increased expansion of Distributed Generation is transforming the way electricity is generated, delivered, consumed, managed, and traded.

Distributed Generation poses challenges on the current distribution and transmission infrastructure which was previously designed for traditional flow of power in one direction, however these challenges present many opportunities for investments, planning and technological growth and development for all parties involved including network operators, stakeholders, and customers.

The benefits of Distributed Generation are not only limited to the customer, but also to network operators by providing ancillary services to help maintain grid stability and reliability.

With appropriate technological advancements, policies, and standardised regulations, Distributed Generation can provide increased value to the power network and improve system reliability whilst reducing overall energy costs.

What is driving Distributed Generation?

Environmental Concerns

Globally there has been increasing concern over greenhouse gas emissions and the impact that they may be having on the environment. Most of the electricity in the UK has traditionally been generated by power stations fuelled by fossil fuels, for example coal, gas and oil. The burning of these fuels makes a significant contribution to greenhouse gas emissions. There is therefore a drive to change the mix of generation technologies we have, to include more low-carbon options.

Technological Innovation

Technology is developing all the time, and due to drivers such as environmental concerns and government policy, there are more generating technologies available now than there were when the National Grid was being developed. For example, wind, wave, solar and biomass generation. Although the connection and integration of these newer generating technologies may pose challenges, innovative technical solutions are being sought to overcome these challenges.

Government Policy

The Department of Energy Security and Net Zero (DESNZ) oversees energy policy and climate change mitigation policy. The UK energy supply is one of DESNZ's key policy areas. DESNZ is developing policy to ensure that in the UK energy supplies are secure, low carbon, and fuelled from a diverse mix of energy supplies. However, DESNZ also has to ensure that energy prices are maintained at affordable levels. Relevant pieces of legislation include:

- Climate Change Act 2008;
- Energy Act 2008; and
- Energy Act 2023.

In December 2024 DESNZ published the Clean Power 2030 Action Plan.

The Climate Change Act sets out legally binding targets for emissions reductions. As such, policy has been developed, which introduces initiatives such as:

- Climate Change Agreement (Climate Change Levy); and
- Zero Carbon Homes.

As well as legislation from the UK Government, the EU also introduced relevant legislation and initiatives, such as the EU Emissions Trading System and the European Third Package, which has resulted in set of European Network Codes. A number of the European Network Codes, including the Requirements for Generators fall under the category of retained EU law and thus remain applicable to the UK following the UKs withdrawal from the European Union.

Security of Supply

The UK increasingly relies on importing fuel, in the form of gas. This introduces a great deal of uncertainty as the cost and reliability of supply is outside of UK control. It is therefore an advantage to have a diverse mix of energy sources, which would make the UK less vulnerable to a restriction in fuel availability or rise in price.

In addition to the environmental concerns, fossil fuels will eventually run out as they are being used much faster than they are being created. As they become scarcer, the prices will rise as the market becomes more competitive. Therefore, to ensure the security of the energy supply into the future, alternative sources are being encouraged.

Benefits of Distributed Generation

There are a number of benefits that increased penetration of Distributed Generation has for the UK and its electricity system. These include:

- Increased energy mix —Distributed Generation is often a renewable source of energy, such as solar, wind or biomass, or uses the energy in a more efficient way as in the case of Combined Heat and Power (CHP) projects. Therefore, increased penetration of Distributed Generation results in a lower carbon mix of energy sources in the electricity system;
- If Distributed Generation is connected close to the point of use, there is a reduced need for the distribution and transmission infrastructure. In some cases, this can delay the need for reinforcement, although the TO and the DNO also need to ensure that the network provides adequate security of supply for its users;
- Where there is a balance between the electricity generation by Distributed Generation and local demand transmission and distribution losses are reduced, when compared with the alternative of the centralised power stations and bulk transmission of electricity; and
- The introduction of local generation in businesses and communities can lead to greater awareness of energy issues.

There are a variety of commercial benefits to having Distributed Generation, which include:

- Self-Consumption, where you use the electricity that you generate to avoid importing from the grid, therefore lowering your electricity bills;
- Selling electricity that you generate, including gaining Smart Export Guarantee (SEG) payments and Contracts for Difference (CFD). This is discussed further in [Section 10: Selling Electricity](#);
- Climate Change Levy Exemption Certificates (LECs) are issued to generators of renewable energy and good quality Combined Heat and Power (CHP). These can be sold to the supplier along with the energy generated. Companies can use LECs to avoid paying the Climate Change Levy tax;
- Embedded benefits of the generating unit being connected to the distribution rather than the transmission network, e.g. charge avoidance of Transmission Network Use of System charges and Balancing Services Use of System charges.

- Generators whose equipment has a capacity greater than 3 MW (and/or the ability to deliver in excess of +/- 15 MVar of reactive power) can enter into agreements with NESO to provide Ancillary Services, for which they will be paid;
- Generation that is not receiving low carbon support (e.g. Feed-in Tariffs, Renewables Obligation) and does not have a long-term contract to provide Short Term Operating Reserves (STOR) NESO could be eligible to enter the Capacity Market and receive payments for delivering energy at times of system stress; and
- EU Emissions Trading System (ETS) - applies to approximately 10,000 energy intensive users in the UK such as metal industry, paper factories and refineries. These large energy users have been allocated green-house gas allowances for their operations. At the end of each year, they must ensure they have enough allowances to cover their emissions: they can buy additional allowances or sell any surplus allowances generated from reducing.

Impacts of Distributed Generation

As well as introducing benefits, the increased penetration of Distributed Generation connected to the distribution system also poses challenges. These will depend on a variety of factors, such as the generation technology, the voltage level the Distributed Generation is connected to, the size of the generating unit(s), the level of export to the distribution system, and on the type of network (e.g. urban or rural).

Some examples of the challenges faced by DNOs by the increased penetration of Distributed Generation include:

- Distributed Generation changes the current flows and shape of the load cycle where they are connected. This could cause:
- Thermal ratings to be exceeded;
- System Voltage to rise above, or fall below, acceptable limits;
- Reverse power flows, i.e. power flows in the opposite direction to which the system has been designed;
- Rise of fault level to increase above the rating of network equipment.
- Adverse power quality impact, for example, voltage distortion, voltage disturbance and voltage unbalance. Note: The technical terms used above are defined in the glossary.

Where to Find More Information

The amount of generation connected to the distribution system has increased significantly since 2010. The benefits and challenges of Distributed Generation are complex, and the industry's understanding of them is evolving as experience increases. For more information on current initiatives in the distribution system, the following documents are useful:

- [Innovation Strategy](#); Energy Networks Association
- [The Open Networks project](#); Energy Networks Association

The following documents are useful if you want more information on Government policy:

- [The Clean Growth Strategy](#); BEIS & DESNZ; 2017 – last updated 2018
- [Transitioning to a net zero energy system; smart systems & flexibility plan](#); BEIS & DESNZ; 2021
- [Clean Power 2030](#); DESNZ, 2024

For the most up to date information on relevant Government policy, refer to the DESNZ website:

- [Department for Energy Security and Net Zero - GOV.UK \(www.gov.uk\)](#)

For more information on Embedded Benefits:

- [Embedded Generation and Embedded Benefits](#); Elexon; March 2019
- For Embedded Benefits information visit the [Ofgem Targeted Charging Review \(TCR\) webpage](#)

Part 1: G98 Single and Multiple Premises

Is this the right Part of the guide for your installation?

Part 1 of this Guide contains the sections relevant to EREC G98 projects for Single Premises and Multiple Premises.

If the Micro-generating Plant has a capacity of 16A per phase or less, and it is connected at low voltage, then this is the correct Part of the Guide for your installation.

If you are installing one Micro-generating Plant at a single premise, then please refer to the relevant EREC G98 Single Premise sections, within this Part of the Guide.

If you are installing multiple Micro-generating Plants at more than one premise within a close geographic region, then please refer to the relevant EREC G98 Multiple Premises sections, within this Part of the guide.

Table 8 and Table 9 provide the structure of the sections within this Part of the Guide.

Table 8: Table showing the Part 1 sections of this Guide relevant for EREC G98 projects

	Section in this Guide							
Project Type	1 & 2: Power Network Background		3: Connection Process		4: The Connection Application Process		5: Cost of Charges	6: Selling Electricity
G98 Single	1	2	3.1	3.3	4.1	4.3	5.1	6.1
G98 Multiple			3.2		4.2		5.2	

Table 9: Table showing the contents of each section within Part 1 of this Guide and the EREC G98 types of projects they are applicable to

Section:	Contents:	Applicable Project Types:
Section 1 – A Guide to the GB Power Sector	A Guide to the GB Power Sector	G98 Single & Multiple Premises
Section 2 – The Role of Distributed Generation	The Role of Distributed Generation	G98 Single & Multiple Premises
Section 3.1 – An Overview of Getting Connected	Introduction	G98 Single Premises
	Getting Connected – Main Tasks	
	Getting Connected – IDNO's Networks	
	Getting Connected – Connect Direct	
Section 3.2 – An Overview of Getting Connected	Getting Connected – Validity of Type Testing	G98 Multiple Premises
	Introduction	
	Getting Connected – Main Tasks	
	Getting Connected – IDNO's Networks	

Section:	Contents:	Applicable Project Types:
	Getting Connected – Connect Direct	
	Getting Connected – Validity of Type Testing	
	Customer Service and Provision of Information	
Section 3.3: G98 Additional Information	Getting Connected – Electricity Storage	G98 Single & Multiple Premises
	Getting Connected – EREC G98 Exceptions	
	Getting Connected – Vehicle to Grid	
	Where to Find More Information	
Section 4.1: G98 Single Premises, The Connection Application Process	Introduction	G98 Single Premises
	The Installation Document	
	Other Requirements	
Section 4.2: G98 Multiple Premises, The Connection Application Process	Introduction	G98 Multiple Premises
	The Connection Application Form	
	Installation and Commissioning	
	The Installation Document	
	Other Requirements	
Section 4.3: G98 Single & Multiple Premises, Additional Information on Compliance	Getting Connected – Guidance on Compliance	G98 Single & Multiple Premises
Section 5.1: G98 Single Premises, Costs and Charges	Use of System Charges	G98 Single Premises
Section 5.2: G98 Multiple Premises, Costs and Charges	Introduction	G98 Multiple Premises
	Connection Charges	
	Connection – Other Elements	
	Use of System Charges	
Section 6.1 Selling Electricity	Introduction	G98 Single & Multiple Premises
	Tariff Structure	
	Eligibility and Accreditation	
	Where to Find More Information	

Section 3: Distribution Generation Connection Process

This section discusses the generation connection process for all Distributed Generation under G98.

- Section 3.1 relates to G98 Single Premises;
- Section 3.2 relates to G98 Multiple Premises;

Section 3.1: G98 Single Premises, An Overview of Getting Connected

This section provides:

- An introduction to getting connected;
- A summary of the main tasks in the process of connecting one or more generation units within a single customer's installation; and
- Guidance on where to find more information.

Introduction

In most cases, the installation of small Micro-generator into a single premises will have very little effect on the distribution system. Therefore, the connection process is relatively simple, and can be summarised as “fit and inform”. The diagram below presents the key actions that you must complete to connect one or more small-scale generation units in a single premises. These tasks are based on the requirements set out in EREC G98 and are described in more detail in this section. The approach detailed in EREC G98 should be used for a single Fully Type Tested Micro-generating Plant connecting to a Customer's Installation at LV, and where the customer Connection Point is at HV provided that there is no other generation connected to the Customer's Installation. EREC G98 does not apply in any case where a Micro-generating Plant is supplying two or more independent Customers via a generation sharing device. All such installations should be applied for under the requirements of EREC G99. See guidance on Page 22.

Figure 4: The key actions to connect one or more small-scale Micro-generators in a single premises

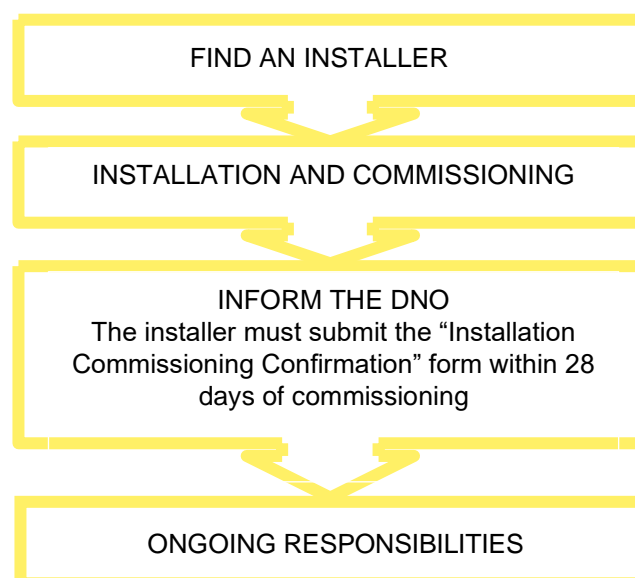

Note that this document covers the process for connecting generation to the distribution system in GB. Northern Ireland has different connection arrangements, for example different versions of EREC G98 and EREC G99 are in use. See: [Find out more about the Distribution Code for Northern Ireland | Northern Ireland Electricity Networks](#).

Getting Connected – Main Tasks

Finding an Installer

The first task is to find a competent installer, who will install Fully Type Tested equipment. Installation must be carried out by installers who are competent and have sufficient skills and training to install a Micro-generator in compliance with EREC G98. This includes having recognised and approved qualifications relating to the primary energy source and general electrical installations. There are companies who design, install and commission domestic generation. They can fully certify and sign off installations. Certified generation products and installers can be found on the following website: <https://mcscertified.com/>

The Microgeneration Certification Scheme is operated by the [MCS Service Company](#). Your installer must be certified for you to claim Smart Export Guarantees. There is more information about this in [Section 6](#).

All Micro-generators connecting under EREC G98 must be Fully Type Tested. This is where the whole Micro-generator is type tested, rather than just part of the Micro-generator.

Installation and Commissioning

Your installer should be aware of the requirements to ensure that installation and commissioning is in line with EREC G98. This includes ensuring that the installation complies with the wiring regulations (BS 7671) and is correctly earthed. Your installer must also ensure, among other things, that:

- No modifications is made to the equipment;
- Appropriate safety labelling is provided;
- The Micro-generators will disconnect from the distribution system if your mains power is interrupted; and
- The Micro-generators is installed in accordance with the manufacturer's instructions.

During the commissioning, your installer will check that your equipment is working as it should.

Informing the DNO

Once your installation and commissioning is complete, the DNO needs to be made aware of your Micro-generator(s). This is so that the DNO can take this into account when operating and designing the network. Your installer must notify the DNO within 28 days of commissioning the generating unit and provide them with information on the installation. This is a legal requirement.

The required information should be captured on an "[Installation Document](#)", which is Form B in EREC G98. These forms are available on the Energy Networks Association website.

Note: DNOs may have their own version of the Installation Document forms on their websites — a web search should help you locate the forms you need or try telephoning your DNO.

Ongoing Responsibilities

Although the focus of this Guide is to inform you about the process of connecting your generation to the distribution system, you should be aware that once it is connected you have some responsibilities. These responsibilities require you to:

- Keep it maintained by someone who is competent to do so;
- Notify your DNO of any operational incidents or failures that affect your compliance with EREC G98; and

- Inform your DNO if you will remove or replace your Micro-generators

Getting Connected – IDNO’s Networks

The process for connecting your Distributed Generation to an IDNO’s network follows EREC G98 or EREC G99 and is therefore similar to connecting to a DNO’s network. IDNOs are licensed entities and are bound by some of the same licence conditions as DNOs, including certain performance standards such as timescales for responding to requests for quotes. The majority of the guidance in this Guide applies to both DNO and IDNO connections.

However, there are a few key differences for a Distributed Generation connection to an IDNO network. The most significant of these is that the IDNO has a relationship with the DNO (or another IDNO) who operates the distribution system that they are connected to. This relationship will not involve you directly but may restrict what the IDNO can readily allow to connect to their network. This is not likely to affect a generation project that is compliant with EREC G98.

To determine whether you are connected to a DNO or IDNO distribution system, refer to Table 7.

Getting Connected - Connect Direct

The ENA has launched [Connect Direct](#) as a single integrated portal to help and streamline the application process for the installation of low carbon technologies with its primary users being installers. Connect Direct was introduced to automate the connection process. This will reduce the amount of information an installer needs to provide and uses machine-to-machine communication to speed up the application process.

Please note that Connect Direct is aimed at connecting smaller devices installed in domestic premises. The portal is being continuously developed but for the time being, more complex connection applications should follow the legacy application process.

Getting Connected - Type Testing Compliance

For information on Type Testing requirements, refer to Page 19.

There has been a recognition that there is a need to provide more clarity on the validity of existing Type-Testing equipment following a new change and requirement in EREC G98 and EREC G99. Some changes and/or additions to EREC G98 may invalidate newly manufactured Micro-generator’s Fully Type Tested status and will require manufacturers who had previously certified devices as being compliant to go through the ENA assessment process again. Manufacturers will need to submit updated certifications for devices so that they can be reassessed before they can be considered to be Fully Type Tested against the revised EREC G98 requirements and hence be suitable for installation on or after the date the revised requirement becomes operative. The same applies to EREC G99.

Minor revisions to EREC G98 and EREC G99, such as clarifications, which do not change the underlying technical requirements, will be issued as formal amendments to the existing version of the EREC, and will not need manufacturers to repeat testing nor submit their devices to the ENA for reassessment.

Changes to EREC G98 and EREC G99 which do change the underlying technical requirements, will be issued as formal amendments to the existing version of the EREC, and will need manufacturers to repeat testing and submit their devices to the ENA for reassessment.

Section 3.2: G98 Multiple Premises, An Overview of Getting Connected

This section provides:

- An introduction to getting connected;
- A summary of the main tasks in the process of connecting one or more generation units within a single customer's installation;
- Customer service and provision of information; and
- Guidance on where to find more information.

Introduction

While the process for connecting Micro-generating Plant in a single premises is relatively simple, the process for connecting small-scale generation in multiple premises is more involved. Projects involving multiple installations could be, for example, a housing refurbishment programme in the same road or street or a new housing development. The approach detailed in EREC G98 should be used for a single Fully Type Tested Micro-generating Plant connecting to a Customer's Installation at LV, and where the customer Connection Point is at HV provided that there is no other generation connected to the Customer's Installation. EREC G98 does not apply in any case where a Micro-generating Plant is supplying two or more independent Customers via a generation sharing device. All such installations should be applied for under the requirements of EREC G99. See guidance on Page 22.

Figure 5: Key actions to connect multiple Micro-generators within different customers' premises in a close geographic region.

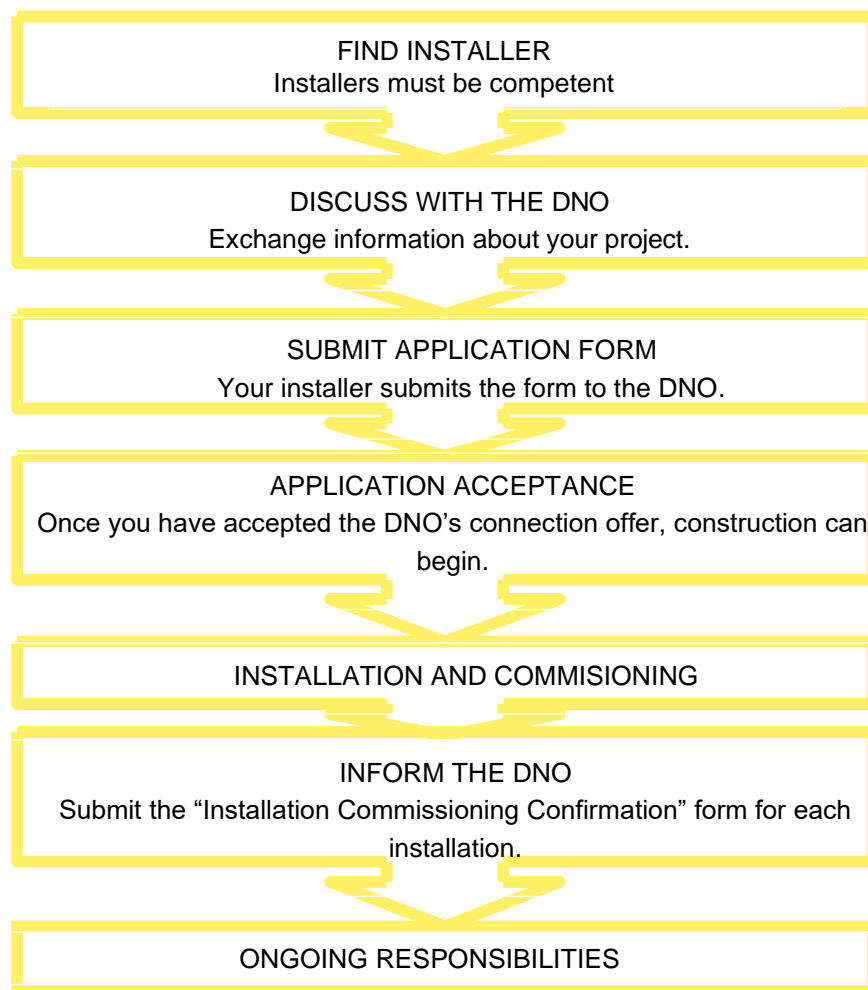

There is a key difference between connecting units at one customer premises and multiple units within different customers' premises within a close geographic region: for multiple sites you need to get approval from the Distribution Network Operator (DNO) before you can connect your Micro-generators.

Figure 5 above presents the key actions that you have to complete to connect multiple of small-scale generation units within different customers' premises which are in a close geographic region. These tasks are based on the requirements set out in EREC G98 and are described further in this section.

Note that this document covers the process for connecting generation to the distribution system in GB. Northern Ireland has different connection arrangements, for example different versions of EREC G98 and EREC G99 are in use. See: [Find out more about the Distribution Code for Northern Ireland | Northern Ireland Electricity Networks](#).

Getting Connected – Main Tasks

Finding an Installer

The first task is to find a competent installer, who will install Fully Type Tested equipment. Installation must be carried out by installers who are competent and have sufficient skills and training to install a Micro-generating

Plant in compliance with EREC G98. This includes having recognised and approved qualifications relating to the primary energy source and general electrical installations. There are companies who design, install and commission domestic generation. They can fully certify and sign off installations. Certified generation products and installers can be found on the following website: <https://mcscertified.com/>

The Microgeneration Certification Scheme is operated by the [MCS Service Company](#). Your installer must be certified for you to claim Smart Export Guarantees. There is more information about this in [Section 6](#).

All Micro-generators connecting under EREC G98 must be Fully Type Tested. This is where the whole Micro-generator is type tested, rather than just part of the Micro-generator.

Discussions with the DNO

You must discuss your plans with the DNO before starting work. You should do this as soon as possible in your planning, as the DNO's response may have a big impact on how you plan your project. You may discuss the feasibility of your connection, and if there will be any charges for connection (charges are discussed further in [Section 5: Costs and Charges](#)).

If your generation project is part of a larger project, eg. developing new housing, then your application needs to be co-ordinated with the connection application for the import connections themselves. The DNO will need to take into account the new generation in the design of the overall connection.

All DNOs provide information to support generation developers, such as capacity heat maps, on their websites. These can be an important source of information. In addition, there may be dedicated generation 'surgeries' or 'drop in' sessions to discuss your project with the DNO.

Submitting an Application Form

Once you have planned the project and exchanged information about your plans with the DNO, you should submit an application form. The format of the application form is given in [Form A](#) in EREC G98, which is available on the Energy Network Association's website. Your installer should submit the application form on your behalf.

Application Acceptance

When you submit your application form you need to include technical details of the equipment. The DNO needs this information to assess the impact that your Micro-generating Plant may have on the distribution system.

Once the DNO has conducted these assessments, they will produce a connection offer. This will specify the conditions for your connection and inform you of any connection charge that you may be asked to pay (charges are discussed further in [Section 5: Costs and Charges](#)). You should ensure that you fully understand this offer before accepting it. You should discuss questions with your DNO if you are unsure.

Installation and Commissioning

Your installer should be aware of the requirements to ensure that installation and commissioning is in line with EREC G98. This includes ensuring that the installation complies with the wiring regulations (BS 7671) and is correctly earthed. Your installer must also ensure, among other things, that:

- No modifications is made to the equipment;
- Appropriate safety labelling is provided;
- The Micro-generators will disconnect from the distribution system if your mains power is interrupted; and
- The Micro-generating Plant is installed in accordance with the manufacturer's instructions.

During the commissioning, your installer will check that your equipment is working as it should.

Informing the DNO

Once your installation and commissioning are complete, the DNO needs to be made aware of your Micro-generator(s). This is so that the DNO can take this into account when operating and designing the network.

Your installer must notify the DNO within 28 days of commissioning the Micro-generators in each premise and provide them with information on the installation — a web search should help you locate the forms you need or try telephoning your DNO.

Ongoing responsibilities

Although the focus of this Guide is to inform you about the process of connecting your generation to the distribution system, you (or the owner of the equipment if that is not you) should be aware that once it is connected you have some responsibilities. These responsibilities require you to:

- Keep it maintained by someone who is competent to do so;
- Notify your DNO of any operational incidents or failures that affect your compliance with EREC G98; and
- Inform your DNO if you will remove one or more Micro-generators.

Getting Connected – IDNO's Networks

The process for connecting your Distributed Generation to an IDNO's network follows EREC G98 or EREC G99, and is therefore similar to connecting to a DNO's network. IDNOs are licensed entities and are bound by some of the same licence conditions as DNOs, including certain performance standards such as timescales for responding to requests for quotes. The majority of the guidance included in this Guide applies to both DNO and IDNO connections. However, there are a few key differences for a Distributed Generation connection to an IDNO network:

- Provision of Information: IDNOs have a reduced set of licence conditions compared with DNOs, and they are not obliged to provide the same documents for customers. IDNOs are not required to produce Long Term Development Statements nor Connection Charging methodologies and statements;
- Interaction between the IDNO and the host network operator: When an IDNO receives an application for connection for Distributed Generation, they design and build the network infrastructure and connect to the host network, which could be operated by a DNO or another IDNO. If your generation project would cause certain network parameters to exceed defined limits, such as voltage or export to the host network, the IDNO and host DNO will explore options for accommodating your project. This discussion will take place between the IDNO and the host DNO, and will not involve you directly. However, the IDNO may then discuss different options with you for the most appropriate generation project to be connected.

To determine whether you are connected to a DNO or IDNO network, refer to Table 7.

Getting Connected - Connect Direct

The ENA has launched Connect Direct as a single integrated portal to help and streamline the application process for the installation of low carbon technologies with its primary users being installers. Connect Direct was introduced to automate the connection process. This will reduce the amount of information an installer needs to provide and uses machine-to-machine communication to speed up the application process.

Please note that Connect Direct is aimed at connecting smaller devices installed in domestic premises. The portal is being continuously developed but for the time being, more complex connection applications should follow the legacy application process.

Getting Connected - Type Testing Compliance

For information on Type Testing requirements, refer to Page 19.

There has been a recognition that there is a need to provide more clarity on the validity of existing Type-Testing equipment following a new change and requirement in EREC G98 and EREC G99. Some changes and/or additions to EREC G98 may invalidate newly manufactured Micro-generator's Fully Type Tested status and will require manufacturers who had previously certified devices as being compliant to go through the ENA assessment process again. Manufacturers will need to submit updated certifications for devices so that they can be reassessed before they can be considered to be Fully Type Tested against the revised EREC G98 requirements and hence be suitable for installation on or after the date the revised requirement becomes operative. The same applies to EREC G99.

Minor revisions to EREC G98 and EREC G99, such as clarifications, which do not change the underlying technical requirements, will be issued as formal amendments to the existing version of the EREC, and will not need manufacturers to repeat testing nor submit their devices to the ENA for reassessment.

Changes to EREC G98 and EREC G99 which do change the underlying technical requirements, will be issued as formal amendments to the existing version of the EREC, and will need manufacturers to repeat testing and submit their devices to the ENA for reassessment.

Customer Service and Provision of Information

There are a number of drivers for DNOs to provide a good level of service to customers, including:

- The current price control proposals;
- Standards of Performance; and
- Discussions at Ofgem DER forums.

Price Control Proposals (RIIO-ED2)

Ofgem administers a price control regime which allows DNOs to earn a fair rate of return while limiting costs passed on to customers. The current price control period is called RIIO-ED2, which runs until 2028. The RIIO-ED2 rules include a number of mechanisms to incentivise DNOs to provide a good service to Distributed Generation customers. The latest information is provided on [Ofgem's website](#).

The previous Incentive on Connections Engagement (ICE) incentive has been replaced in ED2 by the Major Connections Satisfaction Survey (MCCSS) and the Major Connections Annual Report (MCAR).

Guaranteed Standards of Performance

The guaranteed standards of Performance are set out in Standard Licence Condition 15A of the DNO's Distribution Licence. They include, for example, maximum timescales in which DNOs must provide you with a quotation (Connection Offer). Ofgem has guidance documents about these Standards on their [website](#).

DER Technical Forum

The DER Technical Forum, hosted by the ENA on behalf of DNOs, is a forum used to explore issues and concerns around Distributed Generation connections, including barriers to the connection of Distributed Generation and connection process issues. The Forum is open to anyone and are generally attended by DNOs and developers. Further details can be found on the [ENA Events website](#).

Improvements made to DNO Services

In recent years, there have been a number of improvements to DNO services as a response to these drivers and feedback, including:

- Increased internal resources;
- Improved provision of information, including more detailed breakdown of costs, web portals, decision support tools/application hotline, and capacity "heat maps", indicating areas that can more readily facilitate connections;
- Holding stakeholder and customer events; and

- Exploring the possibility for discussions prior to formal application (“connection optioneering”). This process is being carried out in different ways by different DNOs. Refer to your DNO for more information.

DNOs have promised to make continuous improvements to their services, including:

- Shortening connection timescales;
- Enhancing the publicly available network capacity information, eg. contracted capacity reports;
- Publishing case studies;
- Enhancing the connection application and the wayleaves/consents processes; and
- Further developments of Connect Direct.

DNOs publish Distributed Generation 'Work Plans' that outline progress against improvement initiatives. Check your DNO's Distributed Generation web pages. The DNOs have been working with Ofgem and the ENA to improve grid connection timelines. Further information can be found on the [Action Plan](#).

Section 3.3: G98 Additional Information

This section provides:

- A summary of the additional tasks in the process of getting connected; and
- Guidance on where to find more information.

Getting Connected – Electricity Storage

Electricity storage devices that store electrical energy are becoming more prevalent and can be incorporated within Distributed Generation schemes to allow generated electricity to be stored within the premises rather than exported to the distribution system. Electricity storage can also be used to provide ancillary services to network operators and NESO. When assessing the technical impact on their distribution system DNOs treat electricity storage devices as generation; hence they need to be aware of electricity storage devices. Electricity storage devices need to meet the relevant connection requirements set out in EREC G98 or EREC G99, depending on their capacity. These requirements are changing, for example, there is a new requirement for electricity storage devices to switch from import to export mode if the grid frequency falls below a defined threshold.

If you are planning to use electricity storage devices in conjunction with PV (or other technologies) to offset consumption, the total connected generation is likely to be above 16A / phase and hence EREC G99 applies. However, DNOs have implemented a fast-track application process, for some domestic scale electricity storage, depending on the total connected generation. This involves submitting the [G99 Form A1-2: Application for connection of Fully Type Tested Generation under the Small Generation Installation Procedure](#) and reduces the time for the DNO to provide confirmation that the connection is or is not acceptable from 45 days to 10 days or less. If the storage is designed to operate in island mode (eg during a power outage) the fast-track process is not applicable and the standard EREC G99 process applies.

As part of the ENA application form you will be asked to provide the following information:

- Information about electricity storage system installer / operator.
- Details about the storage type (storage only / combined with another technology), storage technology, rating of storage, storage capacity and information regarding import and export capacities.
- Details of operating modes/ commercial service as well as additional operational details.

In addition to the above, the ENA has been working with Ofgem and the DNOs, as part of the ENA's [Action Plan](#) to develop number of 'Tactical Solutions' that works within existing code and licence requirements. These 'Tactical Solutions' have been designed to get better use of the existing network capacity and avoid triggering unnecessary reinforcements. The new solutions went live for connection applications received on or after 30 September 2023. Tactical Solutions 1 and 2 relate to generation projects within the scope of EREC G99, but Tactical Solution 3 is relevant to generation projects within the scope of EREC G99. The ENA's website provides further information on these solutions - [Battery Storage Connections - Tactical Solutions Guidance Notes – Energy Networks Association \(ENA\)](#).

More information can be found [here](#)

Getting Connected – EREC G98 Exceptions

EREC G98 Exceptions

If you are installing a Micro-generator under EREC G98 then the requirements apply in full in most circumstances. However, if your Micro-generator is one of the following, some of the technical requirements in EREC G98 do not apply:

- Classified as an Emerging Technology (see Emerging Technology box on page 20);

- An electricity storage device commissioned before 01 September 2022;
- Has a registered capacity of < 800 W; and
- Operated in infrequent short term parallel operation mode (i.e. operates in parallel with the distribution system no more than 5 minutes in any month, and no more frequently than once per week).

The full details of the requirements that do not apply are described in EREC G98.

If you are installing generating units that are connected via an inverter, the 800 W threshold applies to the aggregate installed capacity of generation. So, for example, if you are installing 3 x 500 W solar PV inverters, the aggregate installed capacity exceeds 800 W and EREC G98 applies in full. If a PV is connected via a single inverter then the rating of the inverter or the aggregate rating of the generation units needs to be < 800W otherwise EREC G98 requirements apply.

Getting Connected

Supply Issues

Your DNO is obligated to maintain the power quality on their network within a set of defined limits. These include maintaining voltage within the required levels. This is so that customer equipment is not damaged. If you have a voltage complaint you should contact your DNO. Your DNO should respond to your complaint within 5 working days, or visit within 7 working days. If work is required to correct the issue, the DNO should complete this within 6 months.

Health and Safety Considerations

Safety is very important in the design of generation connections. Some of the safety requirements for Distributed Generation connections are set out in EREC G98 and EREC G99. This document references the Regulation that informs these requirements, the Electricity Safety, Quality and Continuity Regulations (ESQCR) 2002, and lists the relevant British Standards.

You can find out more about Health and Safety aspects of Distributed Generation connections on the following websites:

The Electrical Safety First (ESF): <https://www.electricalsafetyfirst.org.uk/>

The Energy Networks Association – Safety, health and environment: <https://www.energynetworks.org/keeping-you-safe/commitment-to-public-safety>

Getting Connected – Vehicle to Grid

Vehicle to Grid (V2G) is in its infancy and trials are being undertaken to further understand and demonstrate its benefits. For V2G the electric vehicle will be considered as being both a demand and a generator by DNOs. The application you need to submit will depend on the power export capacity of the V2G unit and whether generation or electricity storage devices are already connected at the designated charging point. It is likely that capacity of the V2G unit will be > 16 A per phase and therefore EREC G99, rather than EREC G98 will apply.

The current situation is that installers should follow one of two generation application processes and sets of forms, which are as follows:

- Where the total of all generation, fixed electricity storage and the power export capacity of the V2G unit is < 50 kW 3-phase or 17 kW single-phase, the EREC G99 simplified application form A1-1 can be used.
- Where the total of all generation, fixed electricity storage and the power export capacity of the V2G unit is > 50 kW 3-phase, the connection application should be made using the ENA standard application form.

In addition, your installer should complete forms associated with a standard (import only) Electric Vehicle (EV) charge point installation and notify the DNO. This is to ensure that the local distribution system can accommodate the demand of your EV charge point or whether reinforcement is required. Such applications

must be completed by your installer on your behalf via the Connect Direct platform, which is available on the [ENA website](#). Alternatively, applications can also be made using the standard DNO connection process. The DNO may request further information, such as a photograph of your electricity meter and the cut-out.

The ENA Low Carbon Technology Workgroup has been looking at ways to simplify the connection application process and associated forms for V2G applications, including considering a single process that combines the aspects of EV as demand and generation.

Where to Find More Information

If you want to find out more on EREC G98, these documents are particularly relevant:

- [Engineering Recommendation G98](#): Requirements for the connection of Fully Type Tested Micro-generators (up to and including 16 A per phase) in parallel with public Low Voltage Distribution Networks on or after 27 April 2019.
- [Electricity Safety, Quality and Continuity Regulations \(ESQCR\) 2002](#), Section 22: Statutory Instrument Number 2665, available free of charge;
- Ofgem’s information about [how to get an electricity connection](#) for a new building or site.
- The [Grid Code](#) - available free of charge on NESO’s website;
- The [Distribution Code](#) of Licenced Distribution Network Operators of Great Britain:- available free of charge on the [Distribution Code](#) website; and
- Engineering Recommendation G59, relating to the connection of generating units to the distribution systems of licensed Distribution Network Operators - available to download free of charge via the [DCode](#) as well as ENA website. This is not applicable to generation connecting after the 27th April 2019.

Other useful documents and links:

- Independent Connections Providers (ICPs): see the [Lloyds Register](#) website information on the National Electricity Registration Scheme (NERS);
- [Electricity Ten Year Statement](#) - available on NESO’s website;
- [Metering Codes of Practice](#)
- Elexon publish [Simple Guides to the BSC](#) and Electricity Trading Arrangements: [A Beginner’s Guide for more information on trading electricity](#);
- The [Connection and Use of System Code \(CUSC\)](#) is available free of charge on NESO’s website;
- NESO also has information on their website about [Connection Reform](#);
- The [Balancing and Settlement Code \(BSC\)](#) is available free of charge on Elexon’s website;
- The [IET Wiring Regulations](#) (British Standard 7671) are available to buy on the IET website; and
- Long Term Development Statements (LTDS) - see below.

Table 10 Table showing list of DNOs and links to their LTDS.

DNO	Link to LTDS
Electricity North West	Long Term Development Statement
Northern Powergrid	Northern Powergrid LTDS
Scottish Power Energy Networks	Long Term Development Statement - SP Energy Networks
Scottish & Southern Electricity Networks	Long term development statements (LTDS) - SSEN

UK Power Networks	<u>Long Term Development Statement and Network Development Plan</u>
National Grid Electricity Distribution	<u>Long Term Development Plans</u>

Submitted by ENA to Penny Carolan (National Grid). Delivered to: pcarolan@nationalgrid.co.uk on 03/04/2025 at 10:08. © ENA 2025. Unauthorised sharing or distribution is prohibited.

Section 4: The Connection Application Process for G98

This section discusses the connection application process for all Distributed Generation under EREC G98.

Section 4.1: G98 Single Premises, The Connection Application Process

This section provides:

- A summary of what the installer of your Micro-generating Plant needs to do to notify the DNO that your generation has been installed and commissioned in accordance with EREC G98; and
- Details of the information that you will need to provide to the DNO.

Introduction

Under the provisions of the Electricity Safety, Quality and Continuity Regulations (ESQCR) you only need to inform the DNO that you have installed your Micro-generating Plant. You do not need to contact the DNO in advance if the total capacity of all your generating units combined is 16A or less per phase at low voltage.

This section of the Guide summarises the information which you will need to provide to your DNO and gives information about the forms that are used for providing the necessary technical details.

The Installation Document

You do not need to talk to your DNO before your generation equipment is commissioned. Your installer must inform the DNO and provide information about the installation **within 28 days of the date of commissioning**. This information is defined in an installation document, which is provided in Form B of EREC G98 Appendix 3. This can be accessed at [Energy Networks Association website](#).

A single integrated portal, Connect Direct, has been launched to help and streamline the application process for the installation of Distributed Generation. More information is available on the [Connect Direct website](#).

Your installer should prepare all of the details requested in the installation document and submit all this with the Form B to confirm that your equipment has been commissioned. The information required includes:

- Details about the site where your Micro-generating Plant has been connected, including your metering information;
- Contact details for the owner of the Micro-generating Plant;
- Technical information about the generating unit itself, including the generating capacity, type test reference and primary energy source;
- Details of the installer of the Micro-generator(s), including the party's accreditation and qualifications;
- Supporting information, e.g. circuit diagrams; and
- A signed declaration as to the compliance of the generating unit with the requirements of EREC G98.

Other Requirements

The declaration that your installer signs on the installation document requires them to confirm that they have installed your generating unit in accordance with EREC G98. It's important that you use an installer who is familiar with the requirements of EREC G98. If you appoint a competent installer (see [Section 3.1: An Overview of Getting Connected](#)), they should know about EREC G98 and make sure that your installation meets with all the relevant standards. You should check that your installer is aware of all these requirements.

Section 4.2: G98 Multiple Premises, The Connection Application Process

This section provides:

- A summary of how to apply to your DNO for connecting Micro-generating Plants in multiple premises;
- Details of the information that you will need to provide to the DNO and the design work they may need to do to assess your connection; and
- A summary of how to notify the DNO that your generation unit(s) has been installed and commissioned in accordance with EREC G98.

Introduction

This section of the Guide describes how to inform your DNO that you are planning to install a number of Micro-generating Plants that fall under EREC G98 into different customer premises within a close geographic region. This section also explains the notifications which the installer of your equipment will need to give to your DNO once the units are commissioned.

The Connection Application Form

The connection application form included in EREC G98 should be completed by your installer if you are planning to install Micro-generators covered by EREC G98 in different customer premises within a close geographic region. This should be submitted before any generation is installed, as the DNO needs to assess the possible impact of the generating equipment on the distribution system. The format for the application is shown in Form A of EREC G98 Appendix 3. This can be accessed at [Energy Networks Association website](#).

The form requires the following:

- Details of the installer of the Micro-generators, including their qualifications; and
- Information on the proposed generating equipment, including the address, meter number, capacity, and type testing reference number.

When the application has been submitted to the DNO by your installer, the DNO will assess the impact of the generation on their network. Where necessary, they will carry out design work, e.g. for network reinforcement. If your generation project is part of a larger project, e.g. developing new housing, then your application needs to be coordinated with the connection application for import supplies. Connection of the generation equipment will only be allowed to proceed after the DNO has approved the application, and any facilitating works for the connection have been completed.

Installation and Commissioning

If the DNO gives permission for the installation of the generation equipment to proceed, your installer will install and commission the Micro-generators. They must then notify the DNO that this has been done, in accordance with the Electricity Safety, Quality and Continuity Regulations (ESQCR). The process and timescales for doing this are described below.

The Installation Document

The installer of your Micro-generators has to tell the DNO about each generation installation within 28 days of the date of commissioning (including the commissioning day itself).

The installation document in EREC G98 captures all the information that the DNO needs once your installer has commissioned each of your generating units. This information is defined in an installation document, which is provided in Form B of EREC G98 Appendix 3. This can be accessed at [Energy Networks Association website](#).

A single integrated portal, Connect Direct, has been launched to help and streamline the application process for the installation of Distributed Generation. More information is available on the [Connect Direct website](#).

Your installer should prepare all of the details requested in the installation document and submit all this with the Form B to confirm that your equipment has been commissioned. The information includes:

- Details about the site where you are connecting your Micro-generator, including metering information;
- Contact details for the owner of the generating unit;
- Technical information about the generating unit itself, including the generating capacity, type test reference and primary energy source;
- Details of the installer of the generating unit, including the party's accreditation and qualifications;
- Supporting information, e.g. circuit diagrams; and
- A signed declaration as to the compliance of the generating unit with the requirements of EREC G98.

One installation document is required for each Micro-generator.

Other Requirements

The declaration that your installer signs on the installation document requires them to confirm that they have installed your generating unit in accordance with EREC G98. It's important that you use an installer who is familiar with the requirements of EREC G98. If you appoint a competent installer (see [Section 3.2. An Overview of Getting Connected](#)), they should know about EREC G98 and make sure that your installation meets with all the relevant standards.

Section 4.3: G98 Single & Multiple Premises, Additional Information on Compliance

Getting Connected – Guidance on Compliance

ENA Type Test Register

The ENA has replaced the Type Test Register which closed on the 16th April 2024. All this functionality and all held data has been migrated across to the [Connect Direct Portal](#). On Connect Direct, you are now able to register new devices, update existing devices and register new users / manufacturers. Connect Direct allows products to be registered with the ENA to be assessed and make them available to installers submitting domestic connection applications, therefore simplifying the connection process and making things more automated.

This register is provided to allow anyone access to the Type Test Verification reports for products relating to electricity generation.

The manufacturer will need to complete a Type Test Verification Report, which demonstrates that the Micro-generator complies with EREC G98 or EREC G99 requirements. Once complete, the Type Test Verification Report should be uploaded and maintained on the Connect Direct portal by the generating unit manufacturer. Connect Direct gives assurance to DNOs and IDNOs that the generating unit connected to their network is fully compliant with EREC G98 or EREC G99 technical requirements. Connect Direct also gives assurance to customers and installers that equipment is suitable to be connected and operated in parallel with the distribution system. When details on a new generating unit, or amendments to an existing generating unit, are submitted to the portal, it is assigned an 'Awaiting Assessment' compliance status. It can take up to 4 weeks for the compliance status to be assessed. Once the ENA compliance assessment is complete, one of the following compliance statuses will be assigned:

- **Compliant:** The Micro-generator has been reviewed against EREC G98 or EREC G99 requirements and is deemed compliant. This is indicative only and the DNOs retain the right to review the suitability of connecting the generating unit to their network.
- **Minor Non-compliance or Document Error:** The Micro-generator cannot be accepted as being compliant due to documentation errors or the need for additional further information or assessment to ensure compliance with EREC G98 or EREC G99. Once the documentation has been updated by the manufacturer, it will be reviewed again.
- **Non-compliant:** The Micro-generator is deemed, based on the submitted evidence, or lack of it, to be non-compliant and requires a revision and update of the information. Non-compliant generation must not be connected in parallel with the network and manufacturers should update and resubmit their evidence to the ENA.

The ENA provides compliance guidance on the previous [Type Test Register website](#) to support manufacturers with:

- Providing the right information in their Type Test Verification Report; and
- Confirming compliance after the ENA's review of the evidence against EREC G98 or EREC G99 requirements.

Further guidance is provided on the Connect Direct Portal. Type Testing of Micro-generators must stay up to date with the most recent EREC G98 updates. Further information is detailed in the breakout box on Type Testing requirements on page 19 of this document.

Key information is summarised below:

- A PowerPoint webinar presented at a manufacturers' workshop on 03 November 2020. This provides an example walkthrough of the EREC G98 Form C (Type Test Verification Report) for a 3 kW Energy

Storage Device, with tips on how to record the right information in the form. The webinar slides contain examples of compliance and non-compliance, including typical errors seen in Type Test Verification Reports. The PowerPoint slides can be accessed via the ENA Type Test Register: <https://www.ena-eng.org/gen-ttr/>;

- Further information on EREC G98/G99 application form guidance: https://www.ena-eng.org/gen-ttr/UserGuide/G98_G99_Guidance_Forms.pdf.

Common Errors on EREC G98 Form C (Type Test Verification Report)

- Incorrect declaration to EREC G98 (ie the registered capacity exceeds the 16 A per phase threshold for EREC G98);
- Confirmation of logic interface is missing;
- Issues with voltage fluctuations / flicker;
- Partially Weighted Harmonic Distortion (PWHd) / Total Harmonic Distortion (THD) values not provided;
- Missing 2nd and 3rd harmonic current values;
- Harmonic current calculation incorrect;
- Fault level contribution missing; and
- Limited Frequency Sensitive Mode— Overfrequency (LFSM-O) active power output does not reduce with the required droop

Section 5: G98 Costs and Charges

This section introduces the rules around connection costs and ongoing costs to facilitate and manage new connections onto the distribution system.

Section 5.1: G98 Single Premises, Costs and Charges

Use of System Charges

Use of System charges are levied by the DNO to the supplier, so as a generator you will not be charged these directly. However, this section is included for your information, as Use of System charges may appear as an item on your bill.

What are Use of System Charges?

Use of System charges cover the development, operation, maintenance, and repair of the distribution system. DNOs make Use of System charges to suppliers. Suppliers may reflect these charges to their customers as either:

- A 'pass-through' item so that the customer can clearly see the Use of System element; or
- 'Wrapped-up' in a total electricity supply tariff where the customer may not be able to clearly see the Use of System element.

DNOs are obliged to publish documents about their Use of System charges. These cover their Use of System charging methodology and a statement of what the charges are for both generation and demand customers. You can find these on DNOs' websites.

All generators connected at Low Voltage are subject to Generation Distribution Use of System charges under the Common Distribution Charging Methodology (CDCM). These charges may be negative (i.e. credits). You can find out more about the Common Distribution Charging Methodology (CDCM) by looking at [Distribution Charging](#) on the Ofgem website, [Distribution Charges Overview](#) on the Energy Networks Association website and some DNOs' websites.

Categories of Use of System Charges

UoS charges are categorised by:

- The voltage level your equipment is connected to and;
- The type of meter you have.

The boxes below define the voltage level that will apply to EREC G98 compliant equipment (Low Voltage) and the metering arrangements that are likely to apply to this equipment (Non-Half Hourly meters). With the Common Distribution Charging Methodology charges for LV generation customers with NHH meters are in the form of unit rates (p/kWh).

LV (Low Voltage)	400/230 V in practice, less than 1kV in general.
-------------------------	--

Non-Half Hourly Meters (NHH)

NHH meters record total energy passing through the meter, but do not record the times the energy is transferred. Typically, the recorded data would be collected a few times a year, eg. every quarter. Most domestic and small commercial properties have NHH meters. You can contact your current electricity supplier to discuss the provision of NHH meters, or other meter suppliers.

Domestic customers are being encouraged to have a smart meter installed. Smart meters record total energy passing through the meter every HH. The introduction of smart meters should improve consumer awareness of energy consumption and will allow for the introduction of time of use tariffs.

Section 5.2: G98 Multiple Premises, Costs and Charges

This section provides:

- An introduction to connection costs;
- The basis of DNO connection charges for infrastructure;
- Information on other elements of connection charges and where to find indicative costs and examples; and
- Information on Generation Distribution Use of System charges.

Introduction

There are two categories of charges made by the DNO:

- **Connection charge:** this is a one-off charge made by the DNO, which primarily covers the cost of work and equipment associated with connecting your generating project to the distribution system. This may include a portion of any reinforcement costs; and
- **Use of System charges:** these are ongoing charges, which primarily cover operation and maintenance costs and include the costs of ongoing network development including general reinforcement.

DNOs are obliged to publish documents describing the basis of their connection charges and their charging methodology. They also present the different elements of connection charges, and indicative costs for works and equipment of significant cost. This will help you to understand the charges they quote you.

This information is contained in the DNOs Statement of Methodology and Charges for Connection to the electricity distribution system. All DNOs' statements follow the same format and are available on their websites. These statements contain:

- The DNO's connection charging methodology (i.e. how they calculate their charges);
- The DNO's connection charging statement (i.e. what the charges are);
- An indication of the costs of providing a connection quotation / budget estimate; and
- Other relevant information for connecting customers.

The basis and elements of connection charges, as well as indicative costs and examples are discussed in this section of the Guide.

Use of System charges are levied by the DNO on the supplier, so as a generator you will not be charged these directly. However, this section is included for your information, as Use of System charges may appear as an item on your bill.

Connection Charges

Depending on the location and size of your Micro-generating Plant, new equipment and reinforcement of the existing network may be necessary to accommodate your generation. In the connection charge, you will be charged for any extension to the network.

DNOs are obliged to publish a document describing the basis of their connection charges and their charging methodology. You can refer to this document to see what costs you will be charged for. These are available on DNO websites.

Connection Charges – Other Elements

Elements of Charges

As well as charges for any network extension (if required), there are other elements that are covered in the connection charge. These can include the following:

- System / feasibility / fault level studies;
- Provision of wayleaves;
- Additional meetings with the DNO or site visits; and
- Administration.

Note that not all DNOs apply charges for all of these items, and that not all of these items will be relevant for your project.

Indicative Costs and Examples

Equipment costs and charges for services vary across DNOs; it could therefore be misleading to list indicative costs in this Guide. If you want to get an idea for indicative costs, the best place to look is the DNO's Statement of Methodology and Charges for Connection. You can find this on the DNO's website.

Aside from giving indicative costs for connection charges, these documents typically contain other useful information, including guidance on the connection process and examples of various connections and their associated cost breakdown. It is updated annually.

The connection charging methodology is governed by the Distribution Connection and Use of System Agreement (DCUSA) and is subject to open governance so any party materially affected by it can propose a change to it. The process for doing this is laid out within the DCUSA itself. See the DCUSA website for more information: <https://www.dcusa.co.uk/dcusa-document/>

The Distribution Charging Methodologies Forum exists to enable parties to discuss ideas for improving the methodology possibly prior to submitting a formal change proposal.

Estimating Costs and Getting a Quotation

As mentioned above, you can obtain indicative costs for works and equipment from DNO documents. To obtain a more accurate picture of the connection costs for your project, you can:

- Ask the DNO for a budget estimate; or
- Obtain an estimate of connection costs from a specialist engineering consultant.

You should exercise care in interpreting budget estimates. DNOs use reasonable endeavours to identify remote reinforcement costs associated with the proposed connection at this stage. However, it is possible that not all of the reinforcement costs will be included at this time.

Payment of Connection Charges

Connection charges are paid either:

- In full at the time that the Connection Offer is accepted; or
- In staged or phased payments, as per a payment schedule.

Staged payments are typically used for generation projects which are greater than a certain size, eg. in project value or duration. The staged payments are generally intended to cover committed expenditure by the DNO.

If your connection does not proceed, it is possible that some of the connection charge will be refundable depending on whether the DNO has carried out any work. You should inform your DNO as soon as possible if you decide not to go ahead with your project.

Charging Futures Forum: The Charging Futures Forum is a programme that co-ordinates significant reform of electricity network access and electricity network charging arrangements. Ofgem is the chair of the programme, and members include generators, network operators, large customers, industry bodies and universities. The programme holds a quarterly forum and teams, called Task Forces, are formed to review specific issues in detail. For more information see the [Charging Futures Forum](#) website.

What is a Budget Estimate?

You may read about budget or indicative estimates and formal quotations. The differences between these two terms are summarised in the following table.

Table 11: Difference between Budget or Indicative Estimates and Formal Quotations.

Budget or Indicative estimate	Formal quotation
Requested in the early stage of a project, and generally, only for larger capital schemes	Requested when electrical requirements have been finalised
The DNO doesn't require much information from you	The DNO requires a lot of information from you
Based on a desktop study—the DNO is unlikely to carry out detailed designs or studies	Based on detailed design work, and may require other input such as site surveys
To give an indication of costs, and is therefore subject to change	Provides formal contract offer
Not open for acceptance	Open to acceptance, subject to conditions

Assuming that you ask the DNO to undertake all of the work involved in your connection, the timescale for the DNO to provide a budget estimate is 10 working days.

Connection Offer expenses (Assessment and Design fees)

Following a government consultation, DESNZ is now allowing DNOs to charge Connection Offer expenses (also known as Assessment and Design fees), regardless of whether or not the subsequent Connection Offer is accepted. Connection Offer expenses are a charge by the DNO for the cost of producing Connection Offers, and cover activities such as network modelling, connection design and site surveys. These changes came into force in April 2018. For further information refer to the [DESNZ website](#).

Note that DNOs apply these charges differently. For example, some are only applying them to projects with certain connection voltages. Refer to your DNO website for details on how they are applying the charges.

Use of System Charges

Use of System charges are levied by the DNO to the supplier, so as a generator you will not be charged these directly. However, this section is included for your information, as Use of System charges may appear as an item on your bill.

What are Use of System Charges?

Use of System charges cover the development, operation, maintenance, and repair of the distribution system. DNOs make Use of System charges to suppliers. Suppliers may reflect these charges to their customers as either:

- A 'pass-through' item so that the customer can clearly see the Use of System element; or
- 'Wrapped-up' in a total electricity supply tariff where the customer may not be able to clearly see the Use of System element.

DNOs are obliged to publish documents about their Use of System charges. These cover their Use of System charging methodology and a statement of what the charges are for both generation and demand customers. You can find these on DNOs' websites.

All generators connected at Low Voltage are subject to Generation Distribution Use of System charges under the Common Distribution Charging Methodology (CDCM). These charges may be negative (i.e. credits). You can find out more about the Common Distribution Charging Methodology (CDCM) by looking at [Distribution Charging](#) on the Ofgem website, [Distribution Charges Overview](#) on the Energy Networks Association website and some DNOs' websites.

Categories of Use of System Charges

UoS charges are categorised by:

- The voltage level your equipment is connected to and;
- The type of meter you have.

The boxes below define the voltage level that will apply to EREC G98 compliant equipment (Low Voltage) and the metering arrangements that are likely to apply to this equipment (Non-Half Hourly meters). With the Common Distribution Charging Methodology charges for LV generation customers with NHH meters are in the form of unit rates (p/kWh).

LV (Low Voltage)	400/230 V in practice, less than 1 kV in general.
------------------	---

Non-Half Hourly Meters (NHH)

NHH meters record total energy passing through the meter, but do not record the times the energy is transferred. Typically, the recorded data would be collected a few times a year, eg. every quarter. Most domestic and small commercial properties have NHH meters. You can contact your current electricity supplier to discuss the provision of NHH meters, or other meter suppliers.

Domestic customers are being encouraged to have a smart meter installed. Smart meters record total energy passing through the meter every HH. The introduction of smart meters should improve consumer awareness of energy consumption and will allow for the introduction of time of use tariffs.

Section 6: Selling Electricity (Smart Export Guarantee)

This section introduces the financial incentives for selling electricity you generate.

Section 6.1: G98 Selling Electricity (Smart Export Guarantee)

This section provides:

- An introduction to the Smart Export Guarantee (SEG) incentive;
- A summary of the eligibility and accreditation arrangements;
- A summary of the deployment caps and how they work; and
- Guidance on where to find more information.

Introduction

Smart Export Guarantees (SEGs) are a financial incentive to support distributed and small-scale renewable energy generation, up to a capacity of 5 MW.

SEGs are available for the following generation technologies:

- Anaerobic digestion (AD);
- CHP and Micro-CHP;
- Hydro;
- Solar PV; and
- Wind.

This section details the structure of the tariffs and will explain how to get accredited with SEGs.

Important Point: The SEG scheme for generators opened on the 1st January 2020. The SEG scheme replaces the Feed-in Tariff (FIT) scheme that closed on the 31st March 2019 but works differently to FITs.

There are two sources of financial benefit from FIT payments which are:

- Generation tariff: A fixed unit for each unit of electricity generated; and
- Export tariff: A guaranteed price for each unit of electricity exported to the grid.

The SEG scheme obliges electricity suppliers to offer an export tariff rate to an eligible **Micro-generating Plant**.

Generators cannot receive SEG payments as well as FIT payments for exported electricity. However, if the generator continues to receive FIT generation payments and opts out of receiving FIT export payments then they are eligible to receive SEG export tariff payments.

Tariff Structure

The main financial benefit from a generation project under the SEG scheme is the export tariff, which is a guaranteed price for each unit of electricity exported to the grid. It is an obligation for licensed electricity suppliers to offer eligible generation projects an export tariff rate. The electricity suppliers decide the SEG export tariff details i.e., the rate and the length of the contract. However, although wholesale electricity prices can fall below zero due to changes in demand, electricity suppliers must always offer a tariff which is greater than zero.

The tariffs are variable and can be adjusted annually for inflation. Generators should contact electricity suppliers in the first instance for more information on the SEG scheme and what rates are offered. A full list of the

electricity suppliers that are offering payments have been published by Ofgem, and you can access them on their webpage below:

<https://www.ofgem.gov.uk/publications/seg-supplier-list>

FIT Scheme – Generation and Export Tariff

Installations which receive payments under the previous FIT scheme will continue to receive the same generation and export tariffs that were current at the time of installation. The last export tariff under the FIT scheme, before the scheme closed on the 31st March 2019, was fixed at 5.24p/kWh. This differs from the export tariff rate offered through the SEG scheme, which depends on the electricity supplier you choose to contract with.

Metering Requirements

All new installations that wish to be paid for electricity exported to the grid must have an export meter installed. The export meter must be capable of taking half-hourly measurements and have an export MPAN (Meter Point Administration Number). The export meter must be located at the point where the installation connects to the distribution system. Smart meters are capable of measuring half-hourly export energy so if you have a smart meter this may be suitable and might not need to be changed.

Your electricity supplier is a good first port of call to discuss metering arrangements. However, note that you can opt to receive SEG payments from a different electricity supplier from your import electricity supplier.

Eligibility and Accreditation

Renewable energy generators under 5 MW are eligible for SEGs.

Accreditation Steps:

For wind or solar PV generation up to and including 50 kW, and for micro-CHP, the accreditation process is as follows:

- Install your generating unit—you must demonstrate that the installation and installer are suitably certified by using a Microgeneration Certification Scheme (MCS) installer (see below);
- Have or arrange to have installed a smart meter to measure export energy every half hour; and
- Apply for a SEG with your electricity supplier, and provide them with any documentation to demonstrate compliance so that they can verify your eligibility.

Your electricity supplier will then be responsible for the level of payment you will receive for the electricity exported, for which you will be required to provide export meter readings. See Ofgem's website below for more guidance on receiving SEG payments:

<https://www.ofgem.gov.uk/environmental-and-social-schemes/smart-export-guarantee-seg>

If your generation equipment is greater than 50 kW, you will be required to demonstrate that the installation is suitably certified. Each electricity supplier will have their own requirements for demonstrating certification, but these are expected to include the EREC G99 Installation Document and proof of ownership.

For all anaerobic digestion and hydro installations, you are required to provide evidence that the installation is suitably certified for a capacity up to and including 5 MW.

For anaerobic digestion installations, an additional step is required to gain accreditation, which involves submitting separate and ongoing documentation to Ofgem, in the form of quarterly sustainability declarations and annual feedstock declarations. Anaerobic digestion installations must use sustainable biogas in order to be eligible for SEG payments. Feedstock that is waste is considered to satisfy sustainability criteria automatically. More information is available on Ofgem's website: <https://www.ofgem.gov.uk/publications/guidance-anaerobic-digestion-generators-seg-sustainability-criteria-and-reporting-requirements>

Microgeneration Certification Scheme (MCS)

The MCS is currently the only formalised industry standard in the UK based on European and international standards for microgeneration projects. MCS is a BS EN ISO/IEC 17065:2012 Certification scheme covering renewable energy products wind and PV up to 50 kW (electrical), solar thermal, biomass and heat pumps up to 45 kW (thermal), Micro CHP and hydropower and renewable energy installation companies. The MCS operator checks the product's performance and quality, the installation methods and quality. Compliance with the MCS requirements should increase your confidence in the renewable energy technology you are buying and in the company installing it.

For more information, please refer to the MCS website: www.microgenerationcertification.org

Multi-technology sites: Electricity suppliers have an obligation to accept a request for SEG payments from a generator that is exporting from an eligible site. However, if the export meter records the energy exported from a combination of eligible and non-eligible sources at the same site, an electricity supplier does not have to make payments. You should check the options and terms from different electricity suppliers carefully.

Local Flexibility Markets: A flexibility provider is a user who provides flexibility services by adjusting the way they consume, generate, or store electricity when requested by the electricity networks. This allows network operators to optimise their capacity, whilst remunerating users for providing this service.

The ENA's Open Networks Project developed the UK's local flexibility market through the formulation of procedures and technical specifications, making energy flexibility markets easier to take part in and more coordinated.

More further information visit the ENA page: [Flexibility Services – Energy Networks Association \(ENA\)](#)

Where to Find More Information

For more guidance and the most up-to-date information on the Smart Export Guarantee, please see the following organisations' websites:

Ofgem – About Smart Export Guarantee (SEG).

<https://www.ofgem.gov.uk/environmental-and-social-schemes/smart-export-guarantee-seg>

Department for Business, Energy and Industrial Strategy (DESNZ) — The future for small-scale low carbon generation: Smart Export Guarantee – government response.

<https://www.gov.uk/government/consultations/the-future-for-small-scale-low-carbon-generation>

Part 2: G99 Type A & Type B-D

Is this the right Part of the guide for your installation?

Part 1 of this Guide contains the sections relevant to EREC G98 projects for Single Premises and Multiple Premises.

If the Power Generating Module (or the aggregation of modules if there is more than one) has a capacity of 16A per phase or more, and it is connected at a voltage other than low voltage, then this is the correct Part of the Guide for your installation.

If your Power Generating Module installation has a Registered Capacity of less than 1MW and a connection point voltage that is below 110kV, then please refer to the relevant EREC G99 Type A Power Generating Module sections, within this Part of the Guide.

If your Power Generating Module installation has a Registered Capacity of 1MW or more, or a connection point voltage of 110kV or more, then please refer to the relevant EREC G99 Type B-D Power Generating Module sections, within this Part of the Guide.

Table 12 and Table 13 provide the structure of the sections within Part 2 of the Guide.

Table 12: Table showing the Part 2 sections of this Guide relevant for G99 projects

	Section in this Guide											
Project Type	1 & 2: Power Network Background		7: Connection Process			8: The Connection Application Process		9: Cost of Charges		10: Selling Electricity		11: Technical and Commercial Interfaces
G99 Type A	1	2	7.1	7.2	7.4	8.1	8.2	9.1	9.3	10.1	10.2	11
G99 Type B-D				7.3		8.3	8.4	9.2				

Table 13: Table showing the contents of each section within Part 2 of this Guide and the types of G99 projects they are applicable to

Section:	Contents:	Applicable Project Types:
Section 1 – A Guide to the GB Power Sector	A Guide to the GB Power Sector	G99 Type A & G99 Type B-D
Section 2 – The Role of Distributed Generation	The Role of Distributed Generation	G99 Type A & G99 Type B-D
Section 7.1: G99 Type A & Type B-D Power Generating Modules	Types of Power Generating Module	G99 Type A & G99 Type B-D
	New and Existing Generation	
	Customer Service and Provision of Information	
	Introduction	G99 Type A

Section:	Contents:	Applicable Project Types:
Section 7.2: G99 Type A, An Overview of Getting Connected	Getting Connected – Main Tasks	
	Getting Connected – Validity of Type Testing	
	Getting Connected – Connect Direct	
	Getting Connected – IDNO's Networks	
Section 7.3: G99 Type B-D, An Overview of Getting Connected	Introduction	G99 Type B-D
	Connection Process Overview	
	Getting Connected – Project Planning Phase	
	Getting Connected – Information Phase	
	Getting Connected – Design Phase	
	Getting Connected – Construction Phase	
	Getting Connected – Testing and Commissioning	
	Getting Connected – Ongoing Responsibilities	
	Getting Connected – Connect Direct	
	Changes to your Power Generating Module	
	Getting Connected – Medium and Large Stations	
	Registered Capacity Definition	
Section 7.4: G99, Additional Information	Getting Connected – IDNO's Networks	G99 Type A & G99 Type B-D
	Getting Connected – Electricity Storage	
	Getting Connected – EREC G99 Exceptions	
	Getting Connected – Vehicle to Grid	
	Getting Connected – Customer Island Operation	
	Where to Find More Information	
Section 8.1: G99 Type A, The Connection Application Process	Introduction	G99 Type A
	The Standard Application Form	
	The Connection Offer	
	Compliance Forms	
	The Installation Document	
	Other Requirements	
Section 8.2: G99 Type A, Additional Information	Getting Connected – Guidance on Compliance	G99 Type A

Section:	Contents:	Applicable Project Types:
Section 8.3: G99 Type B-D, The Connection Application Process	Introduction	G99 Types B-D
	The Connection Application Timeline	
	Initial Discussions with the DNO	
	Information about the Network	
	The Standard Application Form	
	Network Studies	
	The Connection Offer	
	Wayleaves for New Connections	
	Connection Conditions	
	Interactive Connection Applications	
	Accepting a Connection Offer	
	EREC G99 Additional Forms	
EREC G99 Notifications		
Section 8.4: G99 Type B-D, The Connection Application Process – Generation Licensing	Introduction	G99 Types B-D
	Who Requires a Generation Licence?	
	Requirements for a Generation Licence	
	Applying for a Generation Licence	
	National Energy System Operator Interfaces	
	Evaluation of Transmission Impact Assessment Process	
	Where to Find More Information	
	Getting Connected – Guidance on Compliance	
	Reactive Capability across Voltage Range	
Section 9.1: Type A, Costs and Charges	Introduction	G99 Type A
	Connection Charges - Infrastructure	
	Connection Charges – Other Elements	
	Use of System Charges	
	Metering Requirements, Parties and Charges	
Section 9.2: Type B-D, Cost and Charges	Introduction	G99 Types B-D
	Connection Charges - Infrastructure	
	Connection Charges – Other Elements	
	Transmission Connection Charges	

Section:	Contents:	Applicable Project Types:
	Where to Find More Information	
	Ongoing Charges - Introduction	
<u>Section 9.3: Type A & Type B-D, Cost and Charges</u>	Changes to Use of System Charges	G99 Type A & G99 Type B-D
<u>Section 10.1: G99, Selling Electricity (Small Export Guarantee)</u>	Introduction	G99 Type A & G99 Types B-D
	Tariff Structure	
	Eligibility and Accreditation	
	Where to Find More Information	
<u>Section 10.2: G99, Contracts for Difference</u>	Introduction	G99 Type A & G99 Types B-D
	Contracts for Difference (CFD)	
	Renewables Obligation	
	Where to Find More Information	
<u>Section 11: G99 Type B-D, Technical and Commercial Interfaces</u>	Introduction	G99 Types B-D
	Contestable and Non-contestable Work	
	National Electricity Registration Scheme	
	Practicalities of ICP Connections	
	Contracts and Agreements - Introduction	
	Operational Issues - Introduction	

Section 7: Distribution Generation Connection Process

This section discusses the generation connection process for all Distributed Generation.

- Section 7.1 relates to EREC G99 Type A & Type B-D;
- Section 7.2 relates to EREC G99 Type A;
- Section 7.3 relates to EREC G99 Type B-D; and
- Section 7.4 relates to Additional Information

Section 7.1: G99 Type A & Type B-D Power Generating Modules

This section provides:

- An explanation of the terms Power Park Modules and Synchronous Power Generating Modules;
- Guidance on adding new generation to an existing installation; and
- Information about recent developments in the provision of information and customer service standards.

Types of Power Generating Module

Power Park Modules and Synchronous Power Generating Modules

Power Generating Modules are classified in EREC G99 as being either Power Park Modules (PPM) or Synchronous Power Generating Modules (SPGM). Both comprise one or more generating units, which is any apparatus that produces electricity.

Power Park Modules (PPM) are connected to the network either through power electronics (e.g. solar PV or electricity storage devices connected through an inverter) or asynchronously (e.g. some wind turbines are induction or asynchronous generation). They have a single Connection Point to the distribution system.

Synchronous Power Generating Modules (SPGM) are defined in EREC G99 as “an indivisible set of Generating Units (i.e. one or more units which cannot operate independently of each other) which can generate electrical energy such that the frequency of the generated voltage, the generator speed and the frequency of network voltage are in a constant ratio and thus in synchronism.” Where the generating units cannot run independently from each other – e.g. if they have a common shaft – they form a Synchronous Power Generating Module.

In terms of classifying your Power Generating Module as being Type A, B, C or D, for a Power Park Module, this is based on the total capacity of all generating units in the Power Generating Facility (all behind a single Connection Point). For Synchronous Power Generating Modules, this is based on the capacity of each Synchronous Power Generating Module, even if there are multiple modules in a Power Generating Facility. This is illustrated in the diagrams below.

Power Park Module - the classification of Type A to D is based on the capacity of the Power Generating Module (PGM), which is the total capacity of all generating units (GU) in the Power Park Module (PPM):

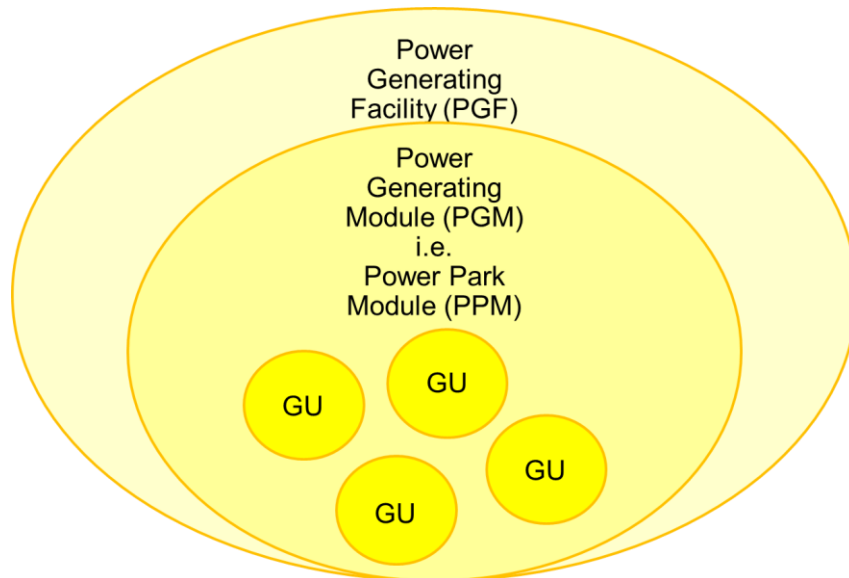

Synchronous Power Generating Module – the classification of Type A to D is based on the capacity of each Synchronous Power Generating Module (SPGM) in the Power Generating Facility (PGF):

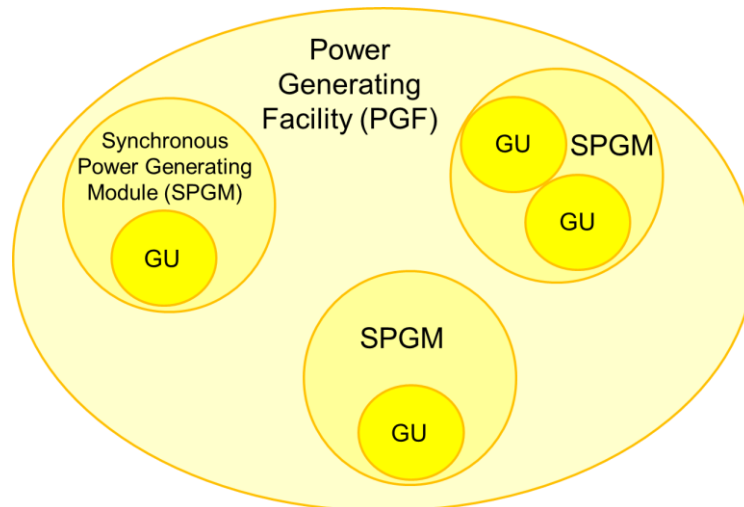

Where generating units are connected via inverters, the inverter rating is deemed to be the generating unit rating.

For example: A Power Generating Facility comprises three 400 kW Synchronous Power Generating Modules (SPGM). Although the capacity of the Power Generating Facility is 1.2 MW, the threshold for requirements is based on the capacity of each Synchronous Power Generating Module. As each is 400 kW, each SPGM must meet the Type A requirements in EREC G99.

Another Power Generating Facility comprises three 400 kW generating units (e.g. Wind turbines), which form a Power Park Module (PPM). The capacity of the Power Park Module is the total capacity of all of the generating units, i.e. 1.2 MW. The Power Park Module must meet the Type B requirements in EREC G99. There are further examples in Section 4 of EREC G99.

New and Existing Generation

Power Park Modules

If you are adding new (i.e. connecting under EREC G99) generating units to an existing (i.e. connected under EREC G59) installation, the new generating units will be treated as a separate Power Park Module. Only the capacity of the new generating units should be taken into account when determining the Type A to D category of the new Power Park Module (even though all units are behind a single Connection Point).

However, this is not the case if you are adding new generating units to an existing Power Park Module installation, where the existing Power Park Module was also installed under EREC G99. In this case, the total capacity of all (i.e. the existing and new) generating units in the Power Park Module will determine the Type category.

This is the same irrespective of the technology – e.g. if there are wind turbines and solar panels behind the same Connection Point, it is the total capacity of all units that determines the compliance requirements.

Synchronous Power Generating Modules

If you are adding new (i.e. connected under EREC G99) Synchronous Power Generating Modules (SPGM) to an existing (i.e. connected under EREC G59) installation, the Type category and hence the compliance requirements for the new SPGMs are determined by the capacity of each new SPGM.

All Power Generating Modules

In all cases, if because of adding generation to an existing installation, the total Registered Capacity of all Power Generating Modules (existing and new) exceeds the threshold for an Embedded Medium Power Station or Large Power Station as defined in the Grid Code, then the Power Generating Facility will need to comply with relevant parts of the Grid Code.

Modifying Existing Power Generating Modules

Generators may want to replace or modify components, protection system, Interface Protection, or increase the Registered Capacity during the lifetime of the Power Generating Module or a Power Generating Facility. In this case, the Generator must notify the DNO before the proposed changes are made.

The existing provisions regarding modification of Power Generating Modules in EREC G99 have been further developed to guide Generators of the implications of making such modifications. First, the DNO and Generator will need to agree on whether the proposed modification is significant or not. If the proposed modification is not significant then the Generator is only required to reconfirm the compliance of the affected component with EREC G99. If a modification is significant then the whole Power Generating Module must be demonstrated to be compliant with EREC G99.

Changes to the generation plant are not intended to trigger expensive compliance related to upgrades unless there is a significant change to the plant and where, in general, Generators are making significant investments. This is intended to avoid costs except where such investment is envisaged by the retained EU law and informed by longstanding GB practices. This aims to benefit Power Park Modules that were compliant with EREC G59 and which need continuous updates.

For more information on the criteria determining whether a change is significant or not refer to [clause 20.3.6](#) of EREC G99. All changes must adhere to the requirements listed in EREC G99's [clause 20.3.7](#) irrespective of whether the modification is significant or not. Further information can be found in [section 20.3](#) and Annex A.6 of EREC G99 or on [Connecting Commercial Generation to the Electricity Networks](#) site on the ENA's website.

The Connection Point and Interface Protection

If you are installing new Power Generating Modules at an existing site (where the existing Power Generating Modules were connected under EREC G59), and where the interface protection is located at the Connection Point, you will need to consider the design of the connection including the location of the interface protection to ensure that all the generation on the site complies with all applicable requirements.

Customer Service and Provision of Information

There are a number of drivers for DNOs to provide a good level of service to customers.

Price Control Proposals (RIIO-ED2)

Ofgem administers a price control regime which allows DNOs to earn a fair rate of return while limiting costs passed on to customers. The current price control period is called RIIO-ED2, which runs until 2028. The RIIO-ED2 rules include a number of mechanisms to incentivise DNOs to provide a good service to Distributed Generation customers. The latest information is provided on [Ofgem's website](#).

The previous Incentive on Connections Engagement (ICE) incentive has been replaced in ED2 by the Major Connections Satisfaction Survey (MCCSS) and the Major Connections Annual Report (MCAR).

Guaranteed Standards of Performance

The guaranteed standards of Performance are set out in Standard Licence Condition 15A of the DNO's Distribution Licence. They include, for example, maximum timescales in which DNOs must provide you with a quotation (Connection Offer). Ofgem has guidance documents about these standards on their [website](#).

DER Technical Forum

The DER Technical Forum, hosted by the ENA on behalf of DNOs, is a forum used to explore issues and concerns around Distributed Generation connections, including barriers to Distributed Generation and process issues. The Forum is open to anyone and are generally attended by DNOs and developers. Details can be found on the [ENA Events website](#).

Improvements made to DNO Services

In recent years, there have been a number of improvements to DNO services as a response to these drivers and stakeholder feedback, including:

- Increased internal resources;
- Improved provision of information, including more detailed breakdown of costs, web portals, decision support tools/application hotline, and capacity "heat maps", indicating areas that can more readily facilitate connections;
- Holding stakeholder and customer events; and
- Exploring the possibility for discussions prior to formal application ("connection optioneering"). This process is being carried out in different ways by different DNOs. Refer to your DNO for more information.

DNOs have committed to bring about continued improvements, including:

- Shortening connection timescales;
- Enhancing the publicly available network capacity information, e.g. Contracted capacity reports;
- Publishing case studies; and
- Enhancing the connection application and the wayleaves/consents processes.

DNOs publish Distributed Generation 'Work Plans' that outline progress against improvement initiatives. Check your DNO's Distributed Generation web pages. The DNOs have been working with Ofgem and the ENA to improve grid connection timelines. Further information can be found on the [Action Plan](#).

The Distribution Code

DNOs are obliged to maintain a Distribution Code under the terms of their licence conditions. The Distribution Code contains technical considerations relating to the connection to and use of the distribution systems. Key areas that are covered by the Distribution Code include, general conditions, planning and connection, operation, and data registration. There are also guidance notes for information. EREC G99 is a Distribution Code Annex 1 document and is therefore an integral part of the Distribution Code. The Distribution Code and hence EREC G99 will be enacted by the Connection Agreement. For more information on the Distribution Code, refer to the Distribution Code website: <https://dcode.org.uk/>. The Distribution Code is under open governance so proposals to make a change to it can be initiated by interested parties. This is done through the Distribution Code Review Panel which includes generator representatives. A list of current representatives can be found on the Distribution Code website at [distribution code review panel](#).

Section 7.2: G99 Type A, An Overview of Getting Connected

This section provides:

- An introduction;
- A summary of the main tasks in the process of connecting Type A Power Generating Modules under EREC G99; and
- A discussion on connecting to an IDNO network.

Introduction

This section describes the process for connecting Type A Power Generating Modules under EREC G99. The technical and compliance requirements are less onerous for Type A Power Generating Modules, compared with Types B to D Power Generating Modules. A Type A Power Generating Module has a capacity between 0.8 kW and 1 MW and is connected to a distribution system operating at below 110 kV. This EREC G99 section of this Guide only applies to Type A Power Generating Modules > 16 A per phase at LV. If you are installing a Power Generating Module that is ≤ 16 A per phase at LV, you should refer to the G98 section of this Guide in Part 1. Figure 6 shows the key steps in the connection process. These tasks are based on the requirements set out in EREC G99.

Figure 6: Key actions to connect G99 Type A units to the distribution network.

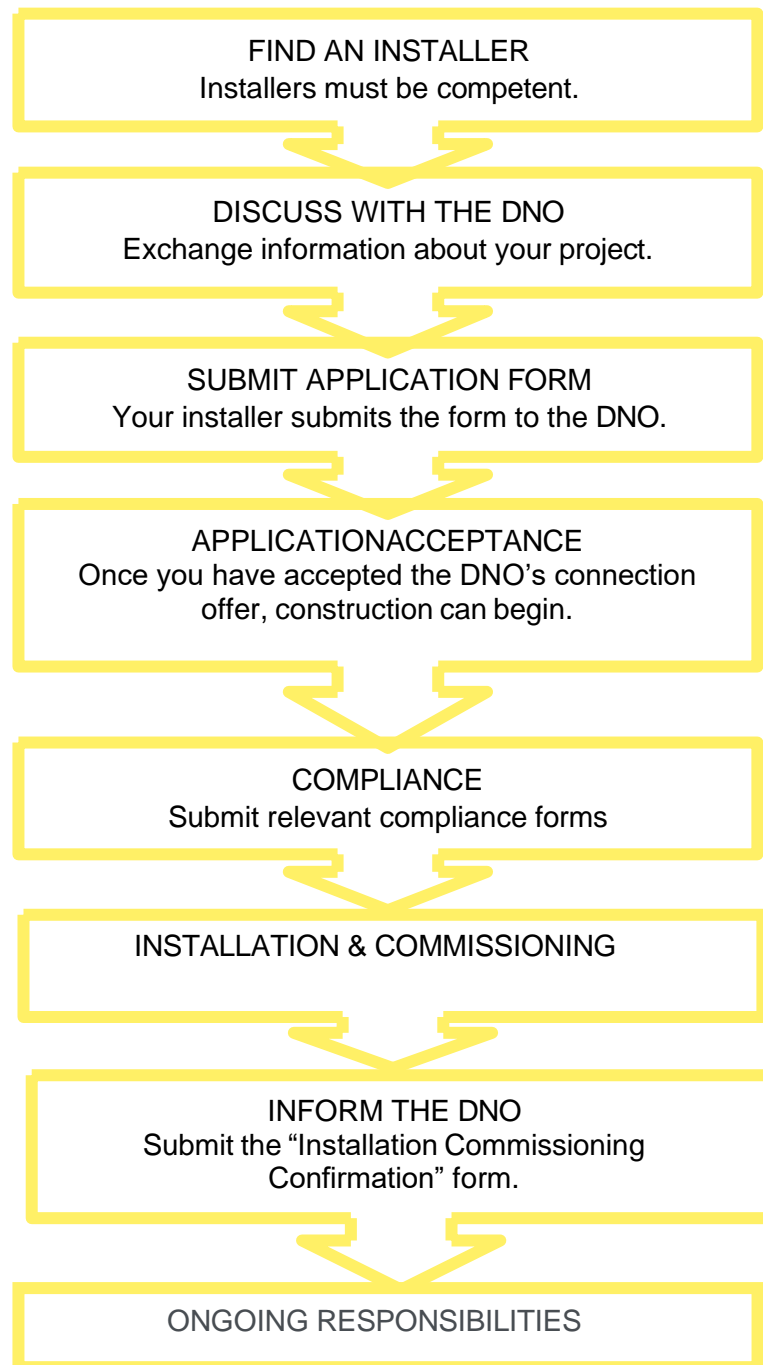

Note that this document covers the process for connecting generation to the distribution system in GB. Northern Ireland has different connection arrangements, for example different versions of EREC G98 and EREC G99 are in use. See: [Find out more about the Distribution Code for Northern Ireland | Northern Ireland Electricity Networks](#)

Getting Connected – Main Tasks

Finding an Installer

The first task is to find a competent installer. There are companies who design, install and commission domestic generation. They can fully certify and sign off installations. For installations up to 50 kW, certified generation products and installers can be found on the following website: <https://mcs-certified.com/>

The Microgeneration Certification Scheme is operated by the MCS Service Company.

Discussions with the DNO

You must discuss your plans with the DNO before starting work. You should do this as soon as possible in your planning, as the DNO's response may have a big impact on how you plan your project. You may discuss the feasibility of your connection, and if there will be any charges for connection (charges are discussed further in [Section 9: Costs and Charges](#)).

All DNOs provide information to support generation developers, such as capacity heat maps, on their websites. These can be an important source of information. In addition, there may be dedicated generation 'surgeries' or 'drop in' sessions to discuss your project with the DNO.

Alternative Connections

Each DNO's current approach to offering alternative connection offers, such as those involving Active Network Management, may be found on their website, noted in any connection offer or determined by discussion with the DNO.

Make Contact with the DNO

Extra information can be obtained by making early contact with the DNO to discuss your project. This may be within dedicated generation 'surgeries' or 'drop in' sessions arranged by the DNO. Discussions might include:

- How close your proposed generation site is to the existing network;
- Whether there are any other planned Distributed Generation projects in the same area; and
- Whether there is any "spare" capacity in the network.

Feasibility Studies (Optional)

At this stage, you could have feasibility studies carried out to assess possible connection layouts and indicative costs. These studies can be conducted by the DNO or an external contractor, for a fee. If you do opt for feasibility studies, they should take into account the standard of security required for the connection between your generating equipment and the DNO's network.

Decide who will Construct the Connection

A key decision you have to take is whether to:

- Appoint an Independent Connections Provider (ICP) to do the Contestable work and the DNO to do the Non-contestable work; or
- Appoint the DNO to carry out all of the work required to provide the connection.

Using an ICP to undertake the contestable work allows the work to be competitively bid for, meaning that it could bring some cost advantages. At the same time, using an ICP results in an additional relationship between the DNO and ICP which will need to be managed. If you are considering contracting an ICP to undertake the Contestable work, you may wish to invite quotations from a number of ICPs, as well as the DNO for comparison.

Contestable and Non-contestable Work

There are certain tasks that DNOs do themselves, so that they can maintain co-ordination and control of their networks. These tasks are called Non-contestable work, as they are not open to competition. Conversely, when work is open to competition it is called Contestable work. Contestable work can be conducted by Independent Connections Providers (ICPs). Often, tasks that involve reinforcing existing distribution systems are Non-contestable. Tasks which include the construction of new infrastructure or extensions to the network tend to be contestable.

For more on this, see the [Section 11: Technical and Commercial Interfaces: Competition in Connections](#).

Submitting an Application Form

Once you have planned the project and exchanged information about your plans with the DNO, you should submit an application form. If your Power Generating Module is less than 50 kW three-phase or 17 kW single-phase, then you can use a simplified application form. The format of the simplified application form is given in Annex A.1 of EREC G99, [which is available from the Energy Network Association's website](#). EREC G99 is also available via the [DCode website](#). Your installer should submit the application form on your behalf. For larger schemes, you should use the standard application form, which is available on the [ENA's website](#).

You should do your best to provide as much of the information required in the application form as possible, to ensure your quote is as accurate as it can be. If you have difficulty filling out this form, you can discuss this with your DNO or engage an adviser such as an engineering consultant to assist you.

The Connect Direct portal can be used as an alternative to submit domestic grid connection applications.

Application Acceptance

When you submit your application form you need to include technical details of the equipment you are planning to install. The DNO needs this information to assess the impact that your generating equipment may have on the network.

Once the DNO has conducted these assessments, they will produce a connection offer. This will specify the conditions for your connection and inform you of any connection charge that you may be asked to pay (charges are discussed further in [Section 9: Costs and Charges](#)). You should ensure that you fully understand this offer before accepting it. You should discuss questions with your DNO if you are unsure. Connection offers are time limited. Your DNO will inform you how long the offer is valid for. If a connection offer expires, there is no guarantee that the same offer will be made again, particularly if your development is in an area where there are many Distributed Generation projects.

Once accepted, connection offers may be withdrawn if the DNO feels that your project is not progressing at a reasonable rate. This is to prevent spare capacity being 'reserved' for projects that in practice are not actually being built. The connection reforms published by the ENA, aims to speed up connection applications. This will enable the DNOs to proactively manage the queue on behalf of all generation customers. Please refer to Page 22 on new approaches to facilitate connections and the [ENA's website](#) for more information.

Enter into Agreements with the DNO

You will need to enter into a number of agreements with the DNO before your generating unit(s) can start operating, such as:

- A Connection Agreement;
- An Adoption Agreement (only if you are using an ICP for your project); and
- An agreement covering the arrangements for operating equipment at the interface between the distribution system and your generating equipment. This may be contained in a Schedule to the Connection Agreement, or in a separate agreement such as a Site Responsibility Schedule or Joint Operational Agreement.

Some of these agreements will need to be in place before construction begins.

Compliance

Power Generating Modules can:

- Be Fully Type Tested, or
- Comprise some Type Tested equipment, and/or use Manufacturers' Information to demonstrate compliance, and/or also require additional on-site testing. See Manufacturers' information below.

Note that there may be a need to demonstrate compliance with power quality standards even if other aspects of the Power Generating Modules are type tested.

If your Power Generating Module is:

- Fully Type Tested, and
- registered with the Energy Networks Association Connect Direct Portal

then your application should include the manufacturer's reference number (the Product ID). In all other cases, you need to provide the DNO with a Compliance Verification Report. The format of these reports is given in [Annex A.2](#) of EREC G99.

There are different forms for Synchronous Power Generating Modules and Power Park Modules.

These forms are completed by the manufacturer of your Power Generating Module. However, you (or your installer on your behalf) should obtain these and submit them to the DNO as part of the connection process.

Manufacturers' Information

Manufacturers' information is a term used in EREC G99. Along with Type Testing and onsite tests, it is another way of demonstrating compliance of a Power Generating Module with EREC G99 by providing information. The information is supplied by the manufacturer to the customer, who should send it to the DNO. The suitability of the information is agreed between the generator and the DNO. Once the DNO is satisfied that the manufacturers' information they have received accurately represents the performance of the generating unit, it may be assigned a reference ID. If your generating unit already has manufacturers' information available and a reference ID, you can use this reference ID in your compliance forms.

Installation and Commissioning

You should maintain close contact with the DNO throughout construction. This is so that you are aware of the timeline of any reinforcement works that they need to do, and you can plan your project with this in mind. Commissioning can only take place once the construction is complete. EREC G99 details the commissioning tests that you or your installer needs to perform. For generating units covered by EREC G99, it is your obligation to undertake appropriate commissioning tests, which the DNO may choose to witness. For a Fully Type Tested Power Generating Module connected at LV, your DNO will not normally need to witness the commissioning testing. However, your DNO may choose to do so. If this is the case, they will state this in their connection offer.

If your commissioning tests are to be witnessed by the DNO, you or your installer should discuss the scope of the testing with the DNO from an early stage, and must submit the scope, time and date of the testing at least 15 days before commissioning takes place.

Informing the DNO

If the DNO decides not to witness the commissioning tests the DNO must be notified no later than 28 days of these being completed and provide them with information on the installation and the full results of the commissioning tests. This information is captured in two forms, both of which are available in EREC G99 and on the ENA website:

- The Installation Document ([Form A3.1](#)); and
- Site Compliance and Commissioning Test Form ([Form A2.4](#)), where required, e.g. if the interface protection is not Type Tested and needs to be tested onsite.

If your commissioning is being witnessed by the DNO, then these forms can be filled out and handed to the DNO representative witnessing the tests.

The forms include a declaration that the installer must sign. This states that the installation complies with EREC G99.

Note: DNOs may have their own versions of these forms on their websites—a web search should help you locate the forms you need or try contacting your DNO.

Ensure the Commercial Arrangements are in Place

If you have made arrangements with a supplier to buy electricity that you export, it is your responsibility to keep them informed of the proposed commissioning programme. In particular they should know the date you expect imports and exports across the connection to start.

Ongoing Responsibilities

Although the focus of this Guide is to inform you about the process of connecting your generation to the distribution system, you should be aware that once it is connected you have some responsibilities. These responsibilities include:

- Keeping your generation equipment maintained by someone who is competent to do so;
- Performing periodic tests that are required by the DNO. They will discuss these with you;
- Informing the DNO if there are changes to the installation that affect the generating characteristics;
- Complying with Health and Safety requirements;
- Inform the DNO if something happens that affects the compliance of your Power Generating Module with EREC G99; and
- When you are decommissioning your generating unit(s), you need to send the DNO certain information. This is detailed in EREC G99 Annex D.1.

Annex D.3 in EREC G99 is called “Main Statutory and other Obligations” and summarises the main obligations of Generators.

Changes to your Power Generating Module

Generators may want to replace or modify components, protection system, Interface Protection, or increase the Registered Capacity during the lifetime of the Power Generating Module. In this case, the Generator must notify the DNO before the proposed changes are made. Refer to Page 73 on modifying existing Power Generating Modules.

Getting Connected - Validity of type testing

For information on Type Testing requirements, refer to Page 19.

There has been a recognition that there is a need to provide more clarity on the validity of existing Type-Testing equipment following a new change and requirement in EREC G98 and EREC G99. Some changes and/or additions to EREC G98 and EREC G99 may invalidate newly manufactured Micro-generator's and Power Generating Modules Fully Type Tested status and will require manufacturers who had previously certified devices as being compliant to go through the ENA assessment process again. Manufacturers will need to submit updated certifications for devices so that they can be reassessed before they can be considered to be Fully Type Tested against the revised EREC G98 and EREC G99 requirements and hence be suitable for installation on or after the date the revised requirement becomes operative.

Minor revisions to EREC G98 and EREC G99, such as clarifications, which do not change the underlying technical requirements, will be issued as formal amendments to the existing version of the EREC, and will not need manufacturers to repeat testing nor submit their devices to the ENA for reassessment.

Changes to EREC G98 and EREC G99 which do change the underlying technical requirements, will be issued as formal amendments to the existing version of the EREC, and will need manufacturers to repeat testing and submit their devices to the ENA for reassessment.

Getting Connected – Connect Direct

The ENA has launched Connect Direct as a single integrated portal to help and streamline the application process for the installation of low carbon technologies with its primary users being installers. Connect Direct was introduced to automate the connection process. This will reduce the amount of information an installer needs to provide and uses machine-to-machine communication to speed up the application process.

Please note that Connect Direct is aimed at connecting smaller devices installed in domestic premises. The portal is being continuously developed but for the time being, more complex connection applications should follow the legacy application process.

Getting Connected – IDNO's Networks

The process for connecting your Distributed Generation to an IDNO's network follows EREC G99, and is therefore similar to connecting to a DNO's network. IDNOs are licensed entities and are bound by some of the same licence conditions as DNOs, including certain performance standards such as timescales for responding to requests for quotes. The majority of the guidance included in this guide applies to both DNO and IDNO connections. However, there are a few key differences for a Distributed Generation connection to an IDNO network:

- Provision of Information: IDNOs have a reduced set of licence conditions compared with DNOs, and they are not obliged to provide the same documents for customers. IDNOs are not required to produce Long Term Development Statements nor Connection Charging methodologies and statements; and
- Interaction between the IDNO and the host network operator: When an IDNO receives an application for connection for Distributed Generation, they design and build the network infrastructure and connect to the host network, which could be a DNO or another IDNO. If your generation project would cause certain network parameters to exceed defined limits, such as voltage or export to the host DNO, the IDNO and host DNO will explore options for accommodating your project. This discussion will take place between the IDNO and the host DNO, and will not involve you directly. However, the IDNO may then discuss different options with you for the most appropriate generation project to be connected.

To determine whether you are connected to a DNO or IDNO network, refer to Table 7.

Section 7.3: G99 Type B-D, An Overview of Getting Connected

This section provides:

- An introduction;
- A summary of the main tasks in the process of getting connected for Type B, C or D Power Generating Modules;
- A summary of what needs to happen after equipment has been commissioned;
- A description of the additional tasks if the Power Generating Facility is classified as being medium or large;
- A discussion on connecting to an IDNO network; and
- Guidance on where to find more information.

Introduction

The tasks that you have to undertake to get connected vary depending on the capacity of the generating plant you want to connect. In general, the bigger the Power Generating Module, the more complex the connection requirements.

This section focuses on the information exchanges that take place between you, as the developer, and the DNO. It also presents the key actions that you have to complete to connect your Power Generating Module(s). These tasks are based on the requirements set out in EREC G99, which is described on in the introductory chapter.

The key stages of the connection process are illustrated in the flow chart in Figure 7. They are discussed in more detail in this section.

Power stations are classified as being Small, Medium or Large, in the Distribution and Grid Codes. Connecting larger Power Generating Modules to the distribution system involves more complexities than for smaller units. This is due to the increased likelihood that the Power Generating Module will have an impact on the distribution system and/or the transmission systems, and involvement with the electricity market. There is a section that explains these complexities in more detail later in this Guide.

This section describes the process for connecting to meet the requirements of EREC G99 for Type B, Type C and Type D Power Generating Modules.

Note that this document covers the process for connecting generation to the distribution system in GB. Northern Ireland has different connection arrangements, for example different versions of EREC G98 and EREC G99 are in use. For more information, refer to the Northern Ireland Electricity website: [Find out more about the Distribution Code for Northern Ireland | Northern Ireland Electricity Networks](#)

Connection Process Overview

Figure 7: Key actions to connect G99 Type B-D units to the distribution system.

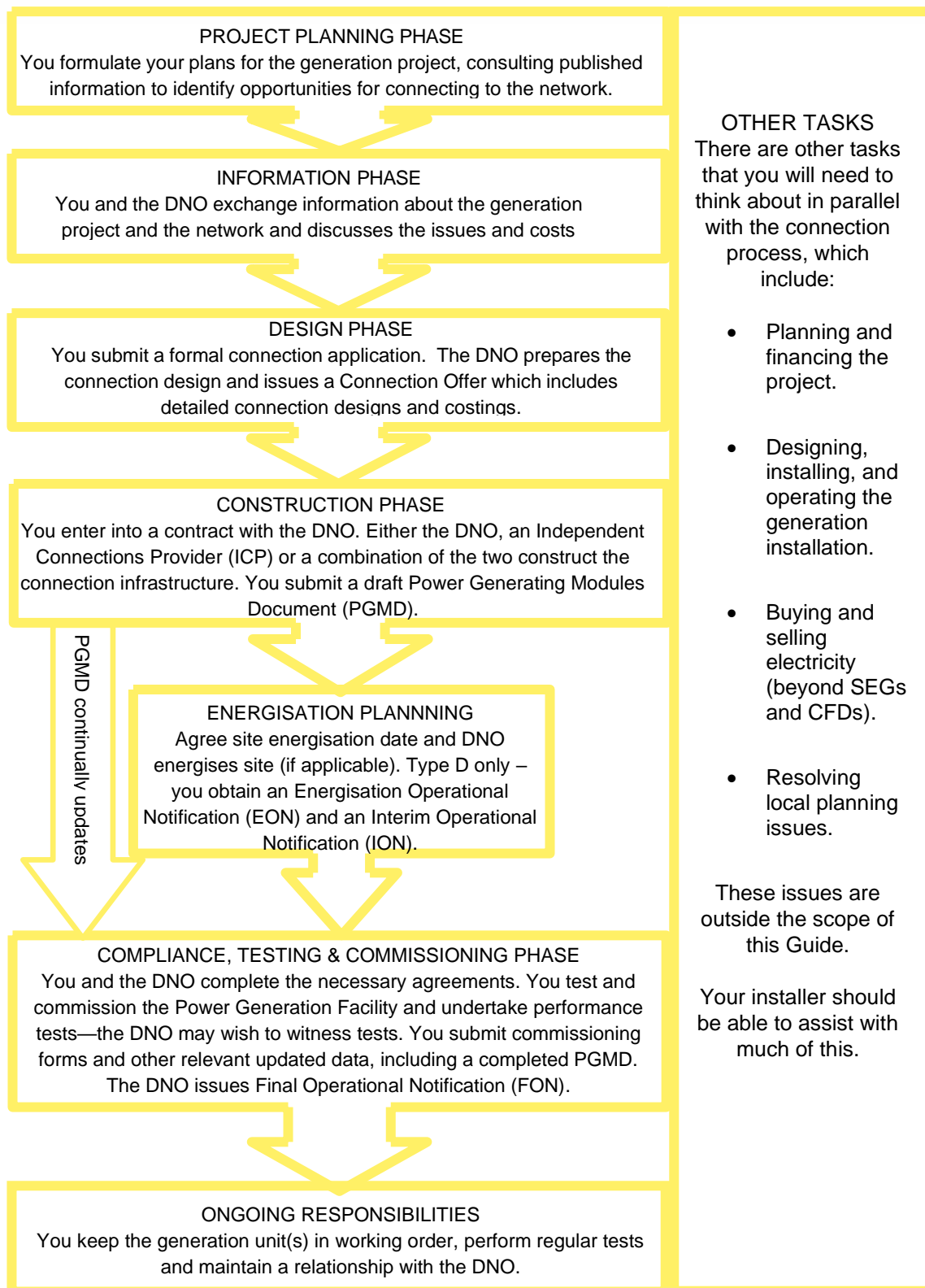

Submitted by ENA to Penny Carolan (National Grid). Delivered to: pcarolan@nationalgrid.co.uk on 03/04/2025 at 10:08. © ENA 2025. Unauthorised sharing or distribution is prohibited.

Getting Connected – Project Planning Phase

The key tasks in the project planning phase are to:

- Identify your DNO (or IDNO);
- Look at publicly available information;
- Make early contact with your DNO; and
- Decide whether to ask for feasibility studies.

Identify your DNO (refer to Table 7 and Figure 2)

There are publicly available documents about the distribution system and transmission system which will enable you to assess the potential to connect generation in the geographical area you're interested in. These include:

- The DNO's Long Term Development Statement (LTDS, see information box below).
- [NESO Electricity 10-year statement](#).

Along with EREC G99, the Distribution Code also sets out some of the technical requirements for connecting to the DNO's network—it may be useful to consult it at this early stage. All DNOs provide additional information to support generation developers, such as capacity heat maps, on their websites. These can be an important source of information.

Alternative Connections

Each DNO's current approach to offering alternative connection offers, such as those involving Active Network Management, may be found on their website, noted in any connection offer or determined by discussion with the DNO.

Make contact with the DNO

Extra information can be obtained by making early contact with the DNO to discuss your project. This may be within dedicated generation 'surgeries' or 'drop in' sessions arranged by the DNO. Discussions might include:

- Whether there are any other planned Distributed Generation projects in the same area; and
- Whether there is any "spare" capacity in the network.

Feasibility Studies (Optional)

At this stage, you could have feasibility studies carried out to assess possible connection options and indicative costs. These studies can be conducted by the DNO or an external contractor, for a fee.

Note: Many DNOs will provide a budget estimate free of charge.

Long Term Development Statement (LTDS)

DNOs prepare a Long Term Development Statement (LTDS) every year. The information should assist anyone considering opportunities (eg. developing a Distributed Generation project) and help potential users to identify constraints in the network. It covers areas such as:

- Development plans for the network;
- Identifying parts of the network that are likely to reach certain limits within five years; and
- Any plans the DNO has to relieve these stressed areas.

An introductory chapter is generally available on the DNO's website. It will allow you to understand the scope of information provided and assess whether it will be useful to you. DNOs will give access to the full document on request. Links to the LTDSs are at the end of this section. The LTDS includes detailed information on parts of the distribution system operating at 33 kV and above, with generic information being provided on the 11 kV network.

Getting Connected - Information Phase

The key tasks in the information phase are to:

- Discuss your plans with the DNO at an early stage;
- Maintain close communication with the DNO throughout the project; and
- Decide whether you will use an Independent Connections Provider (ICP) to do the Contestable work.

Initial Meeting and Communication with DNO

Seek initial meetings with the DNO at an early stage in the development programme to:

- Outline the proposed generation project to the DNO;
- Discuss the process that the DNO will wish to follow through the various stages of the connection development; and
- Ask the DNO to clarify which work will be Contestable and which will be Non-contestable.

You may wish to ask the DNO to prepare an indicative connection design and a budget estimate (after the DNO has undertaken any necessary studies), noting that some DNOs might charge for these.

It is important to maintain close communications with the DNO. This will make sure that the connection design develops in a way that fully reflects the operating characteristics of the equipment.

Decide who will Construct the Connection

A key decision you have to take is whether to appoint:

- An Independent Connections Provider (ICP) to do the Contestable work and the DNO to do the Non-contestable work (often called a SLC15 application, see definition of Contestable and Non-contestable below and information box); or
- The DNO to carry out all of the work required to provide the connection. (often referred to as a Section 16 application, see information box on page 88).

This will affect the way the connection process proceeds, as outlined in the next section: Getting Connected – Design Phase

Using an ICP to undertake the Contestable work allows the work to be competitively bid for, meaning that it could bring some cost advantages. At the same time, using an ICP results in an additional relationship between the DNO and ICP which will need to be managed. If you are considering contracting an ICP to undertake the Contestable work, you may wish to invite quotations from a number of ICPs, as well as the DNO for comparison.

Contestable and Non-contestable Work

There are certain tasks that DNOs do themselves, so that they can maintain co-ordination and control of their networks. These tasks are called Non-contestable work, as they are not open to competition. Conversely, when work is open to competition it is called Contestable work. Contestable work can be conducted by Independent Connections Providers (ICPs). Often, tasks that involve reinforcing the existing distribution system are Non-contestable. Tasks which include the construction of new infrastructure or extensions to the network tend to be contestable.

For more on this, see the [Section 11: Technical and Commercial Interfaces: Competition in Connections](#).

Getting Connected – Design Phase

The key tasks in the design phase are to:

- Submit a formal connection application to the DNO with supporting technical information;
- Receive, review, discuss and agree on the Connection Offer from the DNO; and
- Enter into a formal agreement with the DNO, and the ICP as required.

The choice of who will be undertaking the Contestable work for your connection (DNO or ICP) will affect the process you will follow. This is explained in this section and illustrated in the flow diagram on page 89.

Submit a formal Connection Application

The ENA standard application form includes the technical details of the equipment that the DNO needs to design the connection.

You should do your best to provide as much of this information as possible, to ensure your quote is as accurate as it can be and to enable the DNO to assess your connection application promptly. If you have difficulty filling out this form, you can discuss this with your DNO or engage an adviser such as an engineering consultant to assist you.

The ENA standard application form is used by all DNOs and the DNO will tell you what supporting information they need. On 1 January 2025 ENA published a guidance document to describe to applicants what information they need to provide alongside their completed standard application form. A copy of this guidance is available on the [ENA website](#).

The process of submitting a connection application is covered in [Section 8: The Connection Application](#). If the DNO is doing all the construction work (i.e. the Contestable as well as the Non-contestable work), then the connection application will be submitted by you (or your developer / installer).

If you contract an ICP they will generally liaise with the DNO and arrange for the DNO to provide them with a quote for the Non-contestable work. This will enable the ICP to provide you with the total cost for the Contestable and Non-contestable work.

Even if you contract an ICP, you will generally need to have a relationship with the DNO as well, and some formal agreements between you and the DNO may still be required.

The Connection Offer

You, or an ICP acting on your behalf, will receive a Connection Offer from the DNO. This contains the technical and commercial terms under which the DNO is prepared to carry out the Non-contestable work and, if applicable, the Contestable work.

The DNO must provide the Connection Offer within certain timescales. These timescales are given in the information boxes for SLC15 (when the DNO is providing only the Non-contestable work) and Section 16 (of the Electricity Act) (when the DNO is providing both the Contestable and the Non-contestable work) applications.

The Connection Offer must be reviewed carefully—you may wish to hire an independent consultant to help you. DNOs will be willing to discuss the offer with you before you reach a formal agreement.

If you are unhappy with the Connection Offer, DNOs have a complaints process on their websites. In the event that you are still unable to reach an agreement with the DNO, the matter can be referred to the Energy Ombudsman, and ultimately to Ofgem. See page 88 for a note on dealing with disputes.

When considering the connection design options, there may be options that trade off the need for reinforcement (and hence reduce the capital costs and the timescales) against increased operational restrictions. This is discussed further in [Section 11: Technical and Commercial Interfaces: Operational Issues](#).

Connection Offers are time limited. Your DNO will inform you how long the offer is valid for. If a Connection Offer has expired, there is no guarantee that the same offer will be made again, particularly if your development is in an area where there are many Distributed Generation projects.

Once accepted, Connection Offers may be withdrawn if the DNO feels that your plant is not progressing at a reasonable rate. This is to prevent spare capacity being 'reserved' for projects that in practice are not actually being built. The User Guide to the Queue Management was published in July 2021 on the ENA Website under "Customer information provision and connections"; it is called "[ON21-WS2-P2 Updated Queue Management User Guide \(30 Jul 21\)](#)". You will be asked to provide regular updates about the progress of your project. This will enable the DNOs to proactively manage the queue on behalf of all generation customers.

There is more information about this in [Section 8: Connection Application: Connection Application Process](#).

Dealing with Disputes

If you are not satisfied with a particular aspect of service during the process of connecting your generation, your first port of call should be the party with whom the issue lies, e.g. The DNO, supplier, etc. DNOs have their complaints process set out on their websites. If you still cannot resolve the issue you can contact the Energy Ombudsman: <https://www.ombudsman-services.org/>

If you are still unable to resolve the matter, as a last resort it can be referred to Ofgem.

Formal Agreement

Once you have accepted the Connection Offer, you have entered into a formal agreement with the DNO. The connection process that you will typically follow is illustrated on page 89, Figure 8.

Standard Licence Condition 15 (SLC15)

In order to maintain their licence to own, operate and maintain a distribution system, DNOs are required to comply with a set of licence conditions, called Standard Licence Conditions (SLC). SLC15 is called “Standards for the provision of Non-Contestable Connection Services”. It applies when you are requesting only Non-contestable services from the DNO. SLC15 sets standards in terms of timescales for the DNO to perform certain tasks such as provide quotes, respond to design submissions, and complete final works.

Under SLC15, the timescales for the DNO to provide a quotation for work are:

- 30 working days for Low Voltage (LV) generations connections;
- 50 working days for High Voltage (HV) generation connections; and
- 3 months for Extra High Voltage (EHV) generation connections.

For definitions of LV, HV and EHV please see [Section 9: Costs and Charges](#).

Section 16 of the Electricity Act

The Electricity Act (1989) is one of the primary pieces of legislation governing the power sector in the UK. Section 16 of the Act is called “Duty to supply on request” and sets out the DNO’s obligation to provide connections for electricity supply. This is the legislation that governs applications for generation connections where the DNO is requested to undertake both the Contestable and the Non-contestable work.

The timescales for the DNO to provide a quotation for both Contestable and Non-Contestable work are:

- 45 working days for LV generation connections; and
- 65 working days for HV and EHV generation connections.

For definitions of LV, HV and EHV please see [Section 9. Costs and Charges](#).

Figure 8: The connection process.



Submitted by ENA to: Penny Carolan (National Grid). Delivered to: penny.carolan@nationalgrid.co.uk on 03/04/2025 at 10:08. © ENA 2025. Unauthorised sharing or distribution is prohibited.

Getting Connected – Construction Phase

The key tasks in the construction phase are to:

- Enter into agreements with the DNO before the equipment starts operating;
- Submit a draft Power Generating Module Document (PGMD);
- Communicate with the DNO about reinforcements they may be making to the distribution system;
- For Type D Power Generating Modules only, obtain an Energisation Operational Notification (EON) and an Interim Operational Notification (ION); and
- Focus on other activities such as making appropriate provisions for wayleaves and appointing a meter operator.

Enter into Agreements with the DNO

You need to enter into a number of agreements with the DNO before your generating unit(s) can start operating, such as:

- A Connection Agreement;
- An Adoption Agreement (only if you are using an ICP for your project); and
- An agreement covering the arrangements for operating the interface between the distribution system and your generating equipment. This may be contained in a Schedule to the Connection Agreement, or in a separate agreement such as a Site Responsibility Schedule or Joint Operational Agreement.

Some of these agreements will need to be in place before construction begins.

Submit a Draft PGMD

A Power Generating Module Document (PGMD) is a document that you submit to the DNO to confirm that your Power Generating Module(s) comply with EREC G99. It includes a checklist of criteria to meet, and a pointer to other documents that demonstrate compliance (e.g. reports of simulation studies, results of type testing, manufacturers' information, site tests). You should submit a draft version of the PGMD to the DNO at least 28 days before you want to synchronise your Power Generating Module for the first time.

You re-submit the PGMD once your Power Generating Module has been commissioned, to update it with final data. An example of the PGMD is given in EREC G99 in:

- Annex B.2 for Type B Power Generating Modules; and
- Annex C.2 for Type C and Type D Power Generating Modules.

You must submit one PGMD for each Power Generating Module.

The PGMD has a common cover sheet for the whole Power Generating Facility, and then different sections, depending on whether the Power Generating Module is Synchronous Power Generating Module or a Power Park Module.

Communicate with the DNO

Clear communication lines should be established between you, the DNO and the ICP (where applicable). This is to manage the interface between their work, work on your site and the DNO's work to make sure that you have a coordinated programme for completion of the work, and make sure that the work meets the required standards.

Obtain an EON and an ION

If you are installing a Type D Power Generating Module there are additional notifications you need to obtain. Before energising your internal network for the first time, you need an Energisation Operational Notification (EON). You obtain this from your DNO by:

- Providing a revised standard application form with the most up to date information, and

- Notifying the DNO that you are ready to energise your installation at least 28 days before you wish to do so.

When you want to synchronise your Power Generating Module for the first time you need to obtain an Interim Operational Notification (ION). You obtain an ION by submitting a draft PGMD (see above). The ION may impose limitations on the maximum allowed output of your plant.

Focus on other Activities

During this phase you need to focus on a number of other tasks, which can be carried out in parallel with the above tasks. These tasks include the following:

- Complete the construction of the generating unit(s), which should meet [IET Wiring Regulations](#) — make sure you are using an approved contractor;
- Make appropriate provisions for wayleaves in any lease option required. Generally it is better to resolve wayleave and land related issues as early in the project development as possible—see [Section 8: The Connection Application](#);
- Appoint a Meter Operator—more on this in the [Section 9: Costs and Charges](#); and
- Finalise negotiations with a Supplier who will purchase your energy.

Connection Agreements

The Connection Agreement covers the conditions under which your generating equipment is allowed to be physically connected to the DNO network and remain connected and energised while the network is operating normally. For example, they set out technical and safety requirements. These agreements are likely to be standard documents with project-specific annexes. They will probably be prepared by the DNO for you to discuss, agree and sign.

Firm and Non-firm connections

When submitting a request to import or export onto the distribution system via the ENA standard application form, you will need to state the level of security you require for the connection to the local distribution system. The default assumption is that one circuit will be required, but there are other options. In the past these arrangements have sometimes been referred to as Firm and Non-firm connections. However, there are no universal definitions of these terms across all DNOs and they may be used to mean different things in different DNOs; the changes to the ENA standard application form aims to reduce this uncertainty.

If these terms are used in your Connection Agreement it is important that you and the DNO agree what they mean in the context of your Connection Offer. In general:

- A firm connection has allocated capacity to import or export when the distribution system is operating normally or in a first circuit outage condition as agreed in the Connection Agreement between the connecting customer and the DNO.
- A non-firm connection has allocated capacity to import or export only when the distribution system is operating normally, which allows connecting customers to connect onto the network on the condition that the DNO can restrict their capacity when the network is constrained.

DNO's may offer a curtailable connection to allow a quicker connection to the network. This will include an agreement that the amount which you can import and/or export via your connection may be restricted at certain times until the required reinforcement of the distribution system has been completed. The amount of curtailment in the interim period will be measured and compared against a limit, established by an agreed methodology, above which the DNO will pay you compensation. The curtailment will cease after an agreed end date by which time the necessary network reinforcement should have been completed. See [Section 9: Costs and Charges](#) for more information.

Getting Connected – Testing and Commissioning

In summary, the key tasks in the testing and commissioning phase are to:

- Provide the DNO with detailed information about the test scope at least 28 days before the proposed commissioning date;
- Make sure you have careful liaison with the DNO leading up to and during commissioning;
- Undertake commissioning tests and submit commissioning forms to the DNO; and
- Put commercial arrangements in place and keep the Supplier informed on the commissioning progress.

For generating units covered by EREC G99, it is your obligation to undertake appropriate commissioning tests, which the DNO may choose to witness.

Provide the DNO with Detailed Information

According to EREC G99 you need to provide the DNO with detailed information about testing and commissioning at least 28 days before the proposed commissioning date. This will give the DNO time to make decisions about witnessing commissioning and inspecting the installation. Commissioning test requirements are discussed in EREC G99, section 15.3 (for all generating units) and 15.4 (for non type-tested generating units). The DNO will assess the proposed schedule of tests and confirm the commissioning date. More detailed information on commissioning is provided in Sections 16 to 19 of EREC G99, depending on the Type classification of your Power Generating Module.

Careful Liaison with the DNO

Careful liaison with the DNO will be required during the process of commissioning the connection and the Power Generating Modules. In particular the DNO will want assurance on the state of readiness of your Power Generating Modules(s). You may have auxiliary equipment that is supplied via the connection. If this is the case, you will require the connection to be ready before the Power Generating Module(s) is ready to be operated. This will require close coordination with the DNO. This is formalised as the requirement for an EON (Energisation Operational Notification) for Type D Power Generating Modules.

Undertake Commissioning Tests

You need to record the results of the tests in the Installation and Commissioning Confirmation Form ([Form B3](#) for Type B Power Generating Modules and [Form C3](#) for Types C and D Power Generating Modules). If you are not using Type Tested interface protection and / or you are demonstrating compliance with any other requirements on site you also need to record the results of the tests in the Site Compliance and Commissioning test requirements ([Form B2-2](#) for Type B Power Generating Modules and [Form C2-2](#) for Types C and D Power Generating Modules).

You also need to submit final data required in the PGMD and standard application form e.g. if estimated data was previously used or if information was not previously provided. When the DNO is satisfied that you have demonstrated compliance with EREC G99 they will issue you with a Final Operational Notification (FON). This will form part of your Connection Agreement.

Put Commercial Arrangements in Place

If you have made arrangements with a supplier to buy electricity that you export, it is your responsibility to keep them informed of the proposed commissioning programme. In particular they should know the date you expect imports and exports across the connection to start. The supplier can advise you on making contact with the relevant electricity market authorities (e.g. Elexon). Apart from Feed-in Tariffs, the Smart Export Guarantee and Contracts for Difference, trading electricity is beyond the scope of this Guide. However, we have referenced some useful documents on this topic at the end of this section. Commercial arrangements need to be in place for the purchasing and sale of energy during the commissioning process. These arrangements include making sure the correct metering is installed and working before you start importing and exporting electricity.

Validity of type testing

For information on Type Testing requirements, refer to Page 19.

There has been a recognition that there is a need to provide more clarity on the validity of existing Type-Testing equipment following a new change and requirement in EREC G98 and EREC G99. Some changes and/or additions to EREC G98 and EREC G99 may invalidate newly manufactured Micro-generator's and Power Generating Modules Fully Type Tested status and will require manufacturers who had previously certified devices as being compliant to go through the ENA assessment process again. Manufacturers will need to submit updated certifications for devices so that they can be reassessed before they can be considered to be Fully Type Tested against the revised EREC G98 and EREC G99 requirements and hence be suitable for installation on or after the date the revised requirement becomes operative.

Minor revisions to EREC G98 and EREC G99, such as clarifications, which do not change the underlying technical requirements, will be issued as formal amendments to the existing version of the EREC, and will not need manufacturers to repeat testing nor submit their devices to the ENA for reassessment.

Changes to EREC G98 and EREC G99 which do change the underlying technical requirements, will be issued as formal amendments to the existing version of the EREC, and will need manufacturers to repeat testing and submit their devices to the ENA for reassessment.

Interim Operational Notification Type B and C

As described above an ION is generally only relevant to the commissioning of a Type D Power Generating Module. However, in certain circumstances, it may be impractical to complete all the necessary testing to achieve Final Operational Notification (FON) when commissioning a Type B or Type C Power Generating Module. Therefore, the DNO and Generators, in relation to, Type B and Type C Power Generating Modules may agree to an interim operating regime whilst awaiting the completion of all the necessary tests and data submissions. In such cases, an ION may be issued allowing the interim export of energy for the Generator's commercial purposes at the discretion of the DNO. Please refer to clause 17.3.6 and 18.3.6 in EREC G99 for more information.

Getting Connected – Ongoing Responsibilities

EREC G99 sets out a number of ongoing requirements for you as a developer of Distributed Generation. These are beyond the scope of this guide, but include:

- Periodically test the interface protection and generating equipment. The frequency of these tests should be agreed in discussions with the DNO;
- Keep the Power Generating Module maintained by someone who is competent to do so;
- Inform the DNO if there are changes to the installation that affect the generating characteristics (see below in 'Changes to your Power Generating Module');
- Inform the DNO if something happens that affects the compliance of your Power Generating Module with EREC G99;
- When you are decommissioning your generating unit(s), you need to send the DNO certain information. This is detailed in EREC G99 Annex D.1; and
- Comply with Health and Safety requirements.

Annex D.3 in EREC G99 is called "Main Statutory and other Obligations" and summarises the main obligations on Generators.

Adoption Agreements

If an Independent Connections Provider (ICP) has constructed some of the connection infrastructure, an Adoption Agreement is required to define the terms under which the DNO will take these connection assets into their control and ownership. This is normally sent out with the formal Connection Offer. The Adoption

Agreement is held between the DNO and either you or your ICP, depending on your circumstances and the DNO's processes.

Getting Connected – Connect Direct

The ENA has launched Connect Direct as a single integrated portal to help and streamline the application process for the installation of low carbon technologies with its primary users being installers. Connect Direct was introduced to automate the connection process. This will reduce the amount of information an installer needs to provide and uses machine-to-machine communication to speed up the application process.

Please note that Connect Direct is aimed at connecting smaller devices installed in domestic premises. The portal is being continuously developed but for the time being, more complex connection applications should follow the legacy application process.

Getting Connected - Changes to your Power Generating Module

Generators may want to replace or modify components, protection system, Interface Protection, or Registered Capacity during the lifetime of the Power Generating Module. In that case, the Generator must notify the DNO before the Modification is initiated. Refer to Page 73 on changes to your Power Generating Module.

Getting Connected – Medium and Large Power Stations

The Distribution Code defines Medium Power Stations (which is only relevant in England and Wales) and the Grid Code defines Small Power Stations, Medium Power Stations and Large Power Stations. The definitions of these categories are summarised in Table 14 below. Classification as small, medium or large is based on the aggregate registered capacity of all Power Generating Modules in the Power Generating Facility (as distinct from the RfG Type A to D classification). Find the definition of Registered Capacity below.

To connect a Medium Power Station or a Large Power Station, the connection process is the same as the one described so far. However, there are more complexities with power stations of this size due to involvement with the electricity market and the increased likelihood that the units will impact on the distribution system and transmission systems. This means you are likely to be involved with a number of other aspects you need to understand, which include:

- Application for a Generation licence. Power Stations with a Registered Capacity of 100MW and above needs to be licenced and Power Stations with a Registered Capacity from 50MW to <100MW may be exempt: For more information on Generation Licences, please see Section 8.4: G99 Type B-D, The Connection Application Process – Generation Licensing;
- Balancing and Settlement Code (BSC) participation: If you have a generation licence you are required to become a party to the BSC. Otherwise, whether you participate in the BSC depends on how you want to trade electricity. You need to consider this carefully;
- Connection and Use of System Code (CUSC): If you have a generation licence you will need to become a party to the CUSC. Non-licensed generators can choose to sign the CUSC to benefit from certain trading arrangements. You can see which sections, if any, of the CUSC apply to you in Section 1 of the CUSC, "Applicability of Sections and related Agreements Structure";
- Compliance with the Grid Code: Medium Power Stations have to comply with some sections of the Grid Code. The Distribution Code describes which sections apply. Large Power Stations have to comply with all of the Grid Code; and
- Agreements with National Energy System Operator (NESO): For Medium Power Stations and Large Power Stations there are various agreements you have to enter into or may choose to enter into with NESO. Developers of Small Power Stations may choose to enter into these agreements to benefit from trading opportunities. These agreements are discussed in more detail in Section 8.4.

For more information on all of these issues, please see Section 8: The Connection Application Process and websites of the following organisations:

- Elexon
- NESO

Table 14: Table showing registered capacity categories.

Transmission Owner (Region)	Registered Capacity	
	Medium Power Station	Large Power Station
National Grid Electricity Transmission (England and Wales)	50 to <100 MW	100 MW and above
Scottish Power Transmission plc (Southern Scotland)	N/A	30 MW and above
Scottish Hydro Electric Transmission plc (Northern Scotland)	N/A	10 MW and above

Registered Capacity

For a generating plant, Registered Capacity is the capacity used to establish the technical and commercial requirements and characteristics of the plant, either individually, or in aggregate on the site. It is related to, but not the same as the Maximum Export Capacity or Maximum Import Capacity which defines the maximum flow of electricity at the connection point.

The specific definitions of Registered Capacity are slightly different in EREC G98 and EREC G99.

The Registered Capacity is defined (in EREC G99) as being:

The normal maximum Active Power capacity of:

- A Generating Unit; or
- A Power Generating Module (in the case of a Power Park Module, the lesser of the Inverter(s) rating or the rating of the source); or
- A Power Generating Facility,

as declared by the Generator taking into account the Active Power consumed when producing the same and the production of the required Reactive Power at the Connection Point.

A technical capability of operation 0.95 power factor is generally required at the Connection Point, although for Synchronous Power Generating Modules the relevant power factor is 0.92.

There could be an active and reactive power loss between the Module and the Connection Point. The active power loss is small and usually ignored in practice.

The Intrinsic Design Capacity of all G99 Types, which is the designed maximum Active Power capacity of a Generating Unit or a Power Generating Module, is usually identical to Registered Capacity. In some cases, the Registered Capacity might be limited by the manufacturer to a value which is less than the natural or intrinsic capability of the generation plant. These limitations are semi-permanent and designed by the manufacturer only, never by the Generator.

If the Intrinsic Design Capacity is limited to a lower Registered Capacity, the limitation must be such that it cannot be changed, defeated or overcome without the Registered Capacity being redeclared. In these cases, the nature of the restriction shall be agreed with the DNO.

The ENA standard application form asks for maximum active and reactive export power as well as the Registered Capacity and notes that the Registered Capacity can apply to:

- A Power Generating Facility. This is the total maximum Active Power capacity of the Power Generating Module(s) in the Power Generating Facility, minus the power consumed by the generation process. For a Power Generating Facility with no other demand, you should take account of the requirement to produce Reactive Power at the Connection Point which will mean considering other equipment such as transformers and cables connecting the Generating Units to the Connection Point. For a Power Generating Facility embedded in a private network with demand it is recommended that you discuss the requirement to produce Reactive Power with the DNO. Hence the Registered Capacity (kW) will generally be less than the Apparent Power (kVA).
- A Power Generating Module. This is the maximum Active Power capacity of the Generating Unit(s) comprising the Power Generating Module, minus the power consumed by the generation process. It needs to take account of the requirement to produce Reactive Power, and whether this is at the Connection Point or at the Module terminals. Hence the Registered Capacity (kW) will generally be less than the Apparent Power (kVA). Where a Power Generating Module comprises inverters, the maximum Active Power capacity of the Generating Unit(s) is the lesser of the Inverter(s) rating or the rating of the energy source.

Examples are included in Appendix A to show the process for inverter sizing and determining registered capacity.

Section 7.4: G99, Additional Information

This section provides additional information relevant for G99 Power Generating Modules

IDNO's Networks

The process for connecting your Distributed Generation to an IDNO's network follows EREC G99 and is therefore similar to connecting to a DNO's network. IDNOs are licensed entities and are bound by some of the same licence conditions as DNOs, including certain performance standards such as timescales for responding to requests for quotes. The majority of what is included in this guide applies to both DNO and IDNO connections, including allowing the use of Independent Connections Providers (ICP) to construct network extension.

However, there are a few key differences for a Distributed Generation connection to an IDNO network:

- **Provision of Information:** IDNOs have a reduced set of licence conditions compared with DNOs, and they are not obliged to provide the same documents for customers. IDNOs are not required to produce Long Term Development Statements nor Connection Charging methodologies and statements; and
- **Interaction between the IDNO and the Host Network:** When an IDNO receives an application for connection for Distributed Generation, they design and build the network infrastructure and connect to the host network, which could be operated by a DNO or IDNO. If your generation project would cause certain network parameters to exceed defined limits, such as voltage or export to the host network, the IDNO and host DNO will explore options for accommodating your project. This discussion will take place between the IDNO and the host DNO and will not involve you directly. However, the IDNO may then discuss different options with you for the most appropriate generation project to be connected.

To determine whether you are connected to a DNO or IDNO network, refer to Table 7.

Electricity Storage

Electricity storage devices that store electrical energy are becoming more prevalent and can be incorporated within Distributed Generation schemes to allow generated electricity to be stored within the premises rather than exported to the distribution system. Electricity storage can also be used to provide ancillary services to network operators and NESO. When assessing the technical impact on their distribution system DNOs treat electricity storage devices as generation; hence they need to be aware of electricity storage devices. Electricity storage devices need to meet the relevant connection requirements set out in EREC G98 or EREC G99, depending on their capacity. These requirements are changing, for example, there is a new requirement for electricity storage devices to switch from import to export mode if the grid frequency falls below a defined threshold.

If you are planning to use electricity storage devices in conjunction with PV (or other technologies) to offset consumption, the total connected generation is likely to be above 16A / phase and hence EREC G99 applies. However, DNOs have implemented a fast-track application process, for some domestic scale electricity storage, depending on the total connected generation. This involves submitting the [G99 Form A1-2: Application for connection of Fully Type Tested Generation under the Small Generation Installation Procedure](#) and reduces the time for the DNO to provide confirmation that the connection is or is not acceptable from 45 days to 10 days or less. If the storage is designed to operate in island mode (eg during a power outage) the fast-track process is not applicable and the standard EREC G99 process applies.

As part of the ENA application form you will be asked to provide the following information:

- Information about electricity storage system installer / operator.
- Details about the storage type (storage only / combined with another technology), storage technology, rating of storage, storage capacity and information regarding import and export capacities.
- Details of operating modes/ commercial service as well as additional operational details.

In addition to the above, the ENA has been working with Ofgem and the DNOs, as part of the ENA's [Action Plan](#) to develop number of 'Tactical Solutions' that works within existing code and licence requirements. These 'Tactical Solutions' have been designed to get better use of the existing network capacity and avoid triggering unnecessary reinforcements. The new solutions went live for connection applications received on or after 30 September 2023. Tactical Solutions 1 and 2 relate to generation projects within the scope of EREC G99, but Tactical Solution 3 is relevant to generation projects within the scope of EREC G99. The ENA's website provides further information on these solutions - [Battery Storage Connections - Tactical Solutions Guidance Notes – Energy Networks Association \(ENA\)](#).

More information can be found [here](#)

Electricity Storage Operation

The DNO will undertake system design studies to assess the voltage step change based on the electricity storage worst-case power swing considering Active Power and Reactive Power. As it is unlikely that both parameters will change simultaneously an accurate representation of the storage operation should be provided in the ENA standard application form to allow the DNO to undertake a representative assessment. Before any change is made to the operating arrangements of the electricity storage a modification to the Connection Agreement must be formally requested so that the DNO can assess the capacity of the distribution system to accommodate the revised operating regime.

EREC G99 Exceptions

EREC G99 Exceptions

If you are installing a generating unit under EREC G99 then the requirements apply in full in most circumstances. However, if your generating unit is one of the following, some of the technical requirements in EREC G99 do not apply:

- Classified as an Emerging Technology (see Emerging Technology box on page 20);
- An electricity storage device commissioned before 01 September 2022; and
- Operated in infrequent short term parallel operation mode (i.e. operates in parallel with the distribution system no more than 5 minutes in any month, and no more frequently than once per week).

The full details of the requirements that do not apply are described in EREC G99.

Getting Connected

Supply Issues

Your DNO is obligated to maintain the power quality on their network within a set of defined limits. These include maintaining voltage within the required levels. This is so that customer equipment is not damaged. If you have a voltage complaint you should contact your DNO. Your DNO should respond to your complaint within 5 working days, or visit within 7 working days. If work is required to correct the issue, the DNO should complete this within 6 months.

Health and Safety Considerations

Safety is very important in the design of generation connections. Some of the safety requirements for Distributed Generation connections are set out in EREC G98 and EREC G99. This document references the Regulation that informs these requirements, the Electricity Safety, Quality and Continuity Regulations (ESQCR) 2002, and lists the relevant British Standards.

You can find out more about Health and Safety aspects of Distributed Generation connections on the following websites:

The Electrical Safety First (ESF): <https://www.electricalsafetyfirst.org.uk/>

The Energy Networks Association – Safety, health and environment: <https://www.energynetworks.org/keeping-you-safe/commitment-to-public-safety>

Vehicle to Grid

Vehicle to Grid (V2G) is in its infancy and trials are being undertaken to further understand and demonstrate its benefits. For V2G the electric vehicle will be considered as being both a demand and a generator by DNOs. The application you need to submit will depend on the power export capacity of the V2G unit and whether generation or electricity storage devices are already connected at the designated charging point. It is likely that capacity of the V2G unit will be > 16 A per phase and therefore EREC G99, rather than EREC G98 will apply.

The current situation is that installers should follow one of two generation application processes and sets of forms, which are as follows:

- Where the total of all generation, fixed electricity storage and the power export capacity of the V2G unit is < 50 kW 3-phase or 17 kW single-phase, the EREC G99 simplified application form A1-1 can be used.
- Where the total of all generation, fixed electricity storage and the power export capacity of the V2G unit is > 50 kW 3-phase, the connection application should be made using the ENA standard application form.

In addition, your installer should complete forms associated with a standard (import only) Electric Vehicle (EV) charge point installation and notify the DNO. This is to ensure that the local distribution system can accommodate the demand of your EV charge point or whether reinforcement is required. Such applications must be completed by your installer on your behalf via the Connect Direct platform, which is available on the [ENA website](#). The DNO may request further information, such as a photograph of your electricity meter and the cut-out.

The ENA Low Carbon Technology Working Group has been looking at ways to simplify the connection application process and associated forms for V2G applications, including considering a single process that combines the aspects of EV as demand and generation.

Customer Island Operation

Power Generating Modules may operate principally in parallel with the DNOs distribution system or in island mode. Island mode operation entails the continued operation of Power Generating Modules when the customers installation is disconnected from the distribution system.

Through islanding methods, customers may realise added resilience to their installation and economic benefits. All generation which can operate in island mode must adhere to technical requirements and provisions of EREC G99. The only exemptions to these requirements are Power Generating Modules that never connect to the DNOs distributed network and only ever run in island mode.

Customer Island Operation give rise to four operating modes, OM1-4:

- OM1 - long term paralleling without islanding capability;
- OM2 - long term paralleling with islanding capability;
- OM3 - infrequent short-term paralleling (ie predominantly island operation); and
- OM4 - switched-alternative – ie, no parallel operation.

For more information on the requirements of each operating mode refer to the following sections in EREC G99:

- OM1 see section 7.1 of EREC G99
- OM2 see section 7.2 of EREC G99
- OM3 see section 7.3 of EREC G99
- OM4 see section 7.4 of EREC G99

Generators designing an installation which is suitable for operating mode OM2, like other Generators, are required to submit a schematic diagram to the DNO and display one at the Connection Point.

Customer installations Sites with generation and/or electricity storage shall not disconnect from the distribution system during system disturbances and transition to island mode operation unless certain conditions, specified in EREC G99, are met. This is to respect the fault ride through requirements of the generation.

Rotary uninterruptible power supplies are not considered as being electricity storage devices under EREC G99, because their energy input to the system whilst running in parallel is limited.

Onsite Compliance Monitoring

For all onsite monitoring by the DNO, the Generator shall provide all relevant test signals as agreed between the Generator and the DNO when compliance tests are being undertaken. Information on the signals each Generator should provide to the DNO and their resolution can be found in section 15.9 of EREC G99.

Limited Frequency Sensitive Mode - Overfrequency (LFSM – O)

Power Generating Modules capable of running in island mode must also demonstrate the capability to modulate Active Power at high frequency, as required in EREC G99 section 13.2.4. Detailed studies must be undertaken to ensure that the islanded system will remain stable and compliant. For more information on the studies that must be undertaken refer to section 9.6.4.3 of EREC G99.

When the Power Generating Module will never operate in island mode, simulation studies outlined in Section B.4.5 of EREC G99 may be required to demonstrate the capability to modulate Active Power at high frequency as required by section 13.2.4 of EREC G99.

Where to Find More Information

If you want to find out more on EREC G99, these documents are particularly relevant:

- [Engineering Recommendation G99](#): Requirements for the connection of generation equipment in parallel with the public distribution system on or after 27 April 2019.
- [Electricity Safety, Quality and Continuity Regulations \(ESQCR\) 2002](#), Section 22: Statutory Instrument Number 2665;
- Ofgem’s information about [how to get an electricity connection](#) for a new building or site.
- The [Grid Code](#) - available free of charge on NESO’s website;
- The [Distribution Code](#) of Licenced Distribution Network Operators of Great Britain:- available on the [Distribution Code](#) website;
- Engineering Recommendation G59, relating to the connection of generating units to the distribution systems of licensed Distribution Network Operators - available via the [DCode](#) as well as ENA website. This is not applicable to generation connecting after the 27th April 2019.

Other useful documents and links:

- Independent Connections Providers (ICPs): see the [Lloyds Register](#) website information on the National Electricity Registration Scheme (NERS);
- [Electricity Ten Year Statement](#) - available on NESO’s website;
- [Metering Codes of Practice](#)
- Elexon publish [Simple Guides to the BSC](#) and [Electricity Trading Arrangements: A Beginner’s Guide for more information on trading electricity](#);
- The [Connection and Use of System Code \(CUSC\)](#) is available on NESO’s website;
- NESO also has information on their website about [Connection Reform](#);
- The [Balancing and Settlement Code \(BSC\)](#) is available free of charge on Elexon’s website;
- The [IET Wiring Regulations](#) (British Standard 7671) are available to buy on the IET website;
- Ofgem’s information about [how to get an electricity connection](#) for a new building or site; and
- Long Term Development Statements (LTDS) - see below.

Table 15 Table showing list of DNOs and links to their LTDS.

DNO	Link to LTDS
Electricity North West	Long Term Development Statement
Northern Powergrid	Northern Powergrid LTDS
Scottish Power Energy Networks	Long Term Development Statement - SP Energy Networks
Scottish & Southern Electricity Networks	Long term development statements (LTDS) - SSEN
UK Power Networks	Long Term Development Statement and Network Development Plan
National Grid Electricity Distribution	Long Term Development Plans

Section 8: The Connection Application Process

This section discusses the connection application process for all Distributed Generation.

Section 8.1: G99 Type A, The Connection Application Process

This section provides:

- A summary of how to apply to your DNO to install Power Generating Modules;
- Details of the connection offer that the DNO will produce for your connection; and
- A summary of how to notify the DNO that your Power Generating Modules have been installed and commissioned in accordance with EREC G99.

Introduction

This section of the Guide describes the application process for the connection of your Power Generating Module to the distribution system. This includes the application for connection form, and the connection offer from the DNO.

This section also explains the forms that your installer will need to provide to the DNO, including:

- Compliance forms, and
- Notifications once the units are commissioned.

This section is written for installations where the Power Generation Module to be installed is categorised as being Type A in EREC G99, and where the output is greater than 16A per phase.

There is more information on the connection application process in the Section for EREC G99 Type B–D Power Generating Modules, including:

- Wayleaves for new connections;
- Interactive connection applications; and
- The Evaluation of Transmission Impact process and recent developments in this area.

These are unlikely to be relevant for connecting Type A Power Generating Modules, but if these do impact your project, refer to the EREC G99 Types B-D section of this Guide for more detailed information on these topics.

The Standard Application Form

For Power Generating Modules with capacity less than 50 kW 3-phase or 17 kW single phase there is a simplified connection application form in [Annex A.1 of EREC G99](#), which is available from the ENA website. This form is simpler than the form required for larger Power Generating Modules. It requires information about the site, any existing generation on the site, and some simple details of the equipment you are intending to install.

For larger Power Generating Modules there is a standard application form, which is available on the ENA website and generally on DNO websites.

The ENA standard application form is used by all DNOs and the DNO will tell you what supporting information they need. On 1 January 2025 ENA published a guidance document to describe to applicants what information they needed to provide alongside their completed standard application form. A copy of this guidance is available on the [ENA website](#). An online application process may be available on your DNO's website.

The standard application form contains a comprehensive list of data requirements to assist the DNO with carrying out system studies to assess your connection. You should do your best to provide as much of this

information as possible as part of your connection application to ensure your quote is as accurate as it can be and to enable the DNO to assess your connection application promptly. If you have difficulty with filling out this form, you can discuss this with your DNO or an adviser such as an engineering consultant to assist you.

You or your installer should submit the application form to the DNO before any generation equipment is installed, as the DNO needs to assess the possible impact of your generating equipment on the distribution system.

The standard application form is used as an iterative document, developed as the connection and commission process develops. It is used to record information about your generating units that needs to be provided to the DNO before commissioning, to comply with the requirements set out in the Distribution Code Distribution Data Registration Code (DDRC).

When the application has been submitted to the DNO, they will assess the impact of the generation on their network. Where necessary, they will carry out design work, e.g. for network reinforcement. This will be detailed in your Connection Offer.

The Connection Offer

The Connection Offer that you will receive from your DNO should contain the following information:

- Details of the equipment and works needed to connect your generating units to the distribution system;
- Information about any works needed to extend or reinforce the DNO's network as a result of connecting your generating unit to the distribution system;
- Whether the Connection Offer is for a constrained or unconstrained connection;
- Any technical and commercial terms which will apply for the DNO to construct the connection and provide Use of System services;
- Any other useful information, such as whether the DNO will need to witness commissioning of your generating units.

The offer will also contain details of the costs for the DNO to undertake any work. Further information about these costs is given in [Section 9: Costs and Charges](#). You will have a defined period specified in your Connection Offer within which to accept the offer. This will typically be in the range 30- 90 days. Make sure you are aware how long your acceptance period is, as this can vary across DNOs. There is no guarantee that once a Connection Offer is lapsed that a similar offer can be made again.

Once accepted, Connection Offers may be withdrawn if the DNO feels that your project is not progressing at a reasonable rate. This is to prevent spare capacity being 'reserved' for projects that in practice are not actually being built. You may be asked to provide regular updates about the progress of your project. This will enable the DNOs to proactively manage the queue on behalf of all generation customers.

It is possible that there will be other Distributed Generation in development in the same area of the network. If this is the case, your application may affect, or be affected by, another connection application. In this case all the relevant applications are referred to as "interactive". The DNO will tell you in writing if your connection application is interactive with one or more others. The Connection Offer will also specify that it is interactive with other applications. Connection Conditions

The DNO may include certain conditions or restrictions in order for the connection to be provided. Your Connection Offer will include details of these, and if you need to know more information then you can discuss this with your DNO. You will have to agree to these conditions in order to accept the Connection Offer.

Curtailable or Flexible Connection Offers

The DNO will decide if a connection is viable by considering the worst-case credible scenario for the distribution system. If the connection of your generation would cause equipment ratings or statutory limits to be exceeded, then the DNO would not allow the connection without addressing the issues identified. The DNO may decide that the best thing to do is to reinforce the existing network so that it can accommodate the new power flows. However, this could be prohibitively expensive for your project.

In these cases, or where the customer has requested, the DNO may offer a connection with certain restrictions, such as setting a maximum level for export, or restricting generation export under certain network conditions. This could involve entering into a specific commercial arrangement.

For connection applications received by the DNO, the DNO may offer a curtailable connection to allow a quicker connection to the network. This will include an agreement that your connection may be restricted at certain times until the required reinforcement of the distribution system has been completed. The amount of curtailment in the interim period will be measured and compared against a limit, established by an agreed methodology, above which the DNO will pay you compensation. The curtailment will cease after an agreed end date by which time the necessary network reinforcement should have been completed. See [Section 9: Costs and Charges](#) for more information.

Even with a standard Connection Agreement, in rare operational scenarios it may be necessary for the DNO to restrict the operation of a generator in order to, for example, maintain safety or power quality.

If NESO is involved in your project (e.g. if your DNO has requested an Evaluation of Transmission Impact to identify any transmission system works required), then they can impose conditions on your connection. Your DNO must ensure that NESO conditions are met before they allow connection.

Reactive Power Import / Export

The apparent power at any point on the network is the product of the voltage and current at that point. The apparent power is made up of two components, the active power and the reactive power. It is likely that active power is the electrical power you are more familiar with. It is measured in watts (W) and is the useful power that we import into our houses to run our electrical goods. However, there also needs to be a balance of reactive power on the network. It is the DNOs responsibility to ensure that the distribution system can cater for both real and reactive power. Your generating unit will be capable of controlling the amount of reactive power that it absorbs or produces. All Power Generating Modules need to comply with EREC G99 reactive power capability requirements. It may be possible to mitigate negative effects that your generator might have on the network (e.g., rise in system voltage) by controlling the amount of reactive power you produce or absorb. This may allow you to connect a higher capacity generator. You can discuss this option with your DNO.

Compliance Forms

If your Power Generating Module is Fully Type Tested and registered with the ENA's Connect Direct Portal, it will have a manufacturer's reference number (or Product ID on the ENA website). This means that the Power Generating Module meets the requirements of EREC G99, and the manufacturer has submitted information to the ENA that demonstrates this. You should include the reference number on your application form, and you do not need to submit anything further to demonstrate compliance.

Only when the DNO deems it necessary to ensure system stability and security, appropriately detailed models of Type A (and Type B) Power Generating Modules and their control system will be requested. Table 16 shows the modelling information required depending on the Type of your Power Generating Module.

Table 16 List of information required for different EREC G99 PGM Types

Power Generating Module information	Type A	Type B	Type C	Type D
Detailed models	~	~	✓	✓
Control systems models	~	~	✓	✓
Simulation study results	x	✓	✓	✓
Simulation models	x	x	✓	✓
<i>Simple modelling information</i>	x	✓	x	x

✓ = always needed; ~ = only on request; x = not required

Your Power Generating Module might comprise a mixture of type tested components, components where the compliance is demonstrated using manufacturers' information, and components that will need to be tested on site. In this case you (or your installer) need to submit information to indicate how you are intending to demonstrate compliance with EREC G99. This is done by submitting a Compliance Verification Report for each Power Generating Module. The format of this report is given in Appendix A.2 of EREC G99. There are several options ([Forms A.2-1, A.2-2, A.2-3](#)), depending on the registered capacity of your Power Generating Module, and the type (synchronous, asynchronous, inverter connected). These forms should be submitted to the DNO prior to arranging commissioning.

In some cases (e.g. where interface protection is not Type Tested) you will need to demonstrate elements of compliance on site. You can do this at the time of commissioning (see below). In this case, there is a [Form A.2-4](#) in EREC G99 called "Site Compliance and Commissioning test requirements for Type A Power Generating Modules", which sets out the format of recording the relevant test results. Where the DNO witnesses commissioning, this can be submitted to the DNO on the day. Otherwise, this should be submitted to the DNO within 28 days of the date of commissioning (including the commissioning day itself).

The Installation Document

Commissioning should take place once the installation and connection is complete (or in the case of a phased installation, when each phase is complete). The tests and checks required for commissioning are described in section 15 of EREC G99.

The results of the commissioning tests should be recorded on the Installation Document, which is included in Annex A.3 in EREC G99, available on the ENA website.

You or your installer should fill out this form and sign the declaration at the bottom. The information required includes:

- Details about the site where you are connecting your generating unit, including metering information;
- Contact details for the owner of the generating unit;
- Technical information about the Power Generating Module itself, including the generating capacity, type test reference and technology type;
- Details of the installer of the Power Generating Module, including the party's accreditation and qualifications;
- Supporting information, eg. circuit diagrams; and
- A signed declaration as to the compliance of the power generating module with the requirements of EREC G99; and
- A signed declaration as to the compliance with the site compliance and commissioning tests, if applicable (Form A2.-4).

There are two parts to the Installation Document:

- Part 1 is required for the Power Generating Facility; and
- Part 2 is required for each Power Generating Module.

The Installation Document must be submitted within 28 days of the date of commissioning (including the commissioning day itself). If the DNO witnesses the installation, then the form can be filled in on the day and handed to the DNO representative.

Other Requirements

The declaration that your installer signs on the Installation Document requires them to confirm that they have installed your generating unit in accordance with EREC G99. It's important that you use an installer who is familiar with the requirements of EREC G99. If you appoint a competent installer ([see Section 7: An Overview of Getting Connected](#)), they should know about EREC G99 and make sure that your installation meets with all the relevant standards. You should check that your installer is aware of all these requirements.

Section 8.2: G99 Type A, Additional Information

Getting Connected – Guidance on Compliance

ENA Type Test Register

The ENA has replaced the Type Test Register which closed on the 16th April 2024. As a result, all functionality and all held data has been migrated across to the [Connect Direct Portal](#). On Connect Direct, you are now able to register new devices, update existing devices and register new users / manufacturers. Connect Direct allows products to be registered with the ENA to be assessed and make them available.

This register is provided to allow anyone access to the Type Test Verification reports for products relating to electricity generation.

The manufacturer will need to complete a Type Test Verification Report, which demonstrates that the generating unit complies with EREC G98 or EREC G99 requirements. Once complete, the Type Test Verification Report should be uploaded and maintained on the Connect Direct portal by the generating unit manufacturer. Connect Direct gives assurance to DNOs and IDNOs that the generating unit connected to their network is fully compliant with EREC G98 or EREC G99 technical requirements. Connect Direct also gives assurance to customers and installers that equipment is suitable to be connected and operated in parallel with the distribution system. When details on a new generating unit, or amendments to an existing generating unit, are submitted to the portal, it is assigned an 'Awaiting Assessment' compliance status. It can take up to 4 weeks for the compliance status to be assessed. Once the ENA compliance assessment is complete, one of the following compliance statuses will be assigned:

- **Compliant:** The generating unit has been reviewed against EREC G98 or EREC G99 requirements and is deemed compliant. This is indicative only and the DNOs retain the right to review the suitability of connecting the generating unit to their network.
- **Minor Non-compliance or Document Error:** The generating unit cannot be accepted as being compliant due to documentation errors or the need for additional further information or assessment to ensure compliance with EREC G98 or EREC G99. Once the documentation has been updated by the manufacturer, it will be reviewed again.
- **Non-compliant:** The generating unit is deemed, based on the submitted evidence, or lack of it, to be non-compliant and requires a revision and update of the information. Non-compliant generation must not be connected in parallel with the network and manufacturers should update and resubmit their evidence to the ENA.

The ENA provides compliance guidance on the previous [Type Test Register website](#) to support manufacturers with:

- Providing the right information in their Type Test Verification Report; and
- Confirming compliance after the ENA's review of the evidence against EREC G98 or EREC G99 requirements.

Further guidance is provided on the Connect Direct Portal. Type Testing of Micro-generators and Power Generating Modules must stay up to date with the most recent EREC G98 and EREC G99 updates. Further information is detailed in the breakout box on Type Testing requirements on page 19 of this document.

Key information is summarised below:

- A PowerPoint webinar presented at a manufacturers' workshop on 03 November 2020. This provides an example walkthrough of the EREC G98 Form C (Type Test Verification Report) for a 3 kW Energy Storage Device, with tips on how to record the right information in the form. The webinar slides contain examples of compliance and non-compliance, including typical errors seen in Type Test Verification

Reports. The PowerPoint slides can be accessed via the ENA Type Test Register: <https://www.ena-eng.org/gen-ttr/>;

- Further information on EREC G98/G99 application form guidance: https://www.ena-eng.org/gen-ttr/UserGuide/G98_G99_Guidance_Forms.pdf.

Common errors on forms

Examples of common errors in the EREC G99 Form A2-3 are as follows:

- Confirmation of logic interface is missing;
- Issues with voltage fluctuations / flicker;
- Partially Weighted Harmonic Distortion (PWHHD) / Total Harmonic Distortion (THD) values not provided;
- Missing 2nd and 3rd harmonic current values;
- Harmonic current calculation incorrect;
- Fault level contribution missing; and
- Limited Frequency Sensitive Mode— Overfrequency (LFSM-O) active power output does not reduce with the required droop

The different compliance forms (EREC G99 forms A2-1, A2-2, A2-3), which are relevant to your Power Generating Module are illustrated in the diagram below.

Figure 9: Diagram showing the application of the different compliance verification forms.

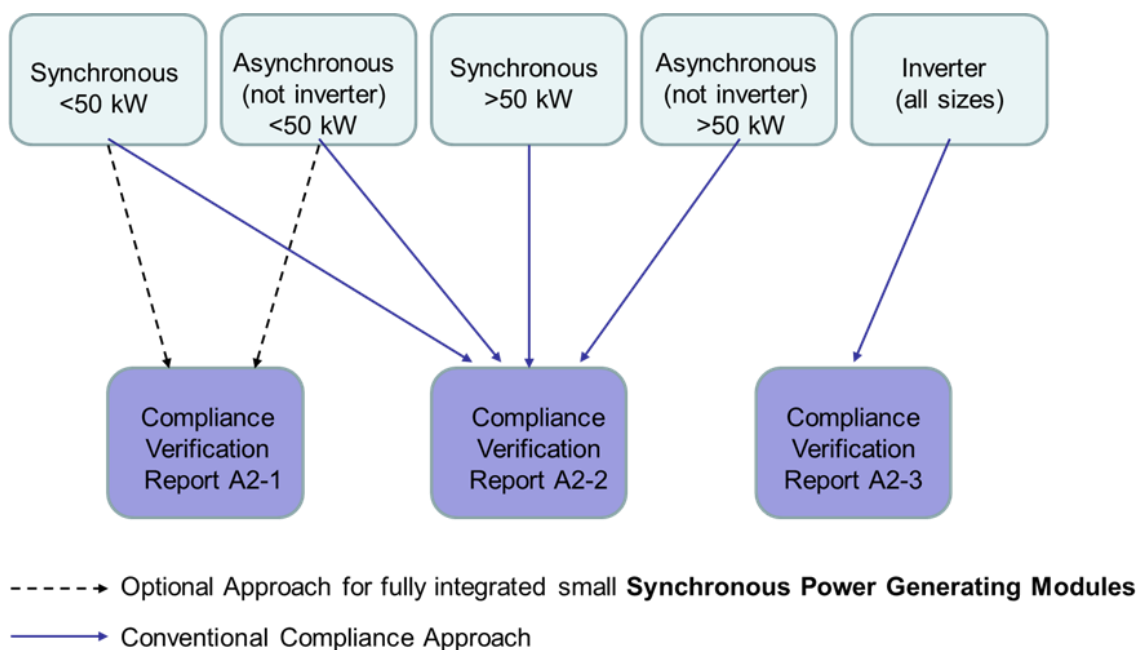

Type Test Options

An extract of the [EREC G99 A2-3](#) (Verification Report for Type A Inverter Connected Power Generating Modules) form is provided below. This form is for inverter connected generation and is the most commonly used of all the Type A Power Generating Module compliance forms. The form can be used to demonstrate compliance of:

1. Fully type tested Power Generating Modules (≤ 50 kW); all tests should be complete;
2. A type tested product (part of a Power Generating Module such as a Generating Unit, Inverters and the Interface Protection) with test results;

3. One-off Installation where the Manufacturer or Installer can confirm that the Power Generating Module has been tested to satisfy all or part of the requirements in EREC G99
4. A Power Generating Module where elements are to be tested on site during the commissioning.

Columns 2 – 4 of the extract in Figure 10, should be used to indicate (e.g. with ticks) which tests are being demonstrated in the form.

Figure 10: Testing options on form A2-3.

There are four options for Testing: (1) Fully Type Tested, (2) Type Tested product, (3) one-off installation, (4) tested on site at time of commissioning. The check box below indicates which tests in this Form have been completed for each of the options. <u>With the exception of Fully Type Tested PGMs</u> tests may be carried out at the time of commissioning (Form A2-4). Include reference(s) for Manufacturers' Information including the ENA Type Test Verification Report Register Product ID number where applicable.				
Tested option:	1. Fully Type Tested	2. Type Tested product	3. One-Off Manufacturers' Info.	4. Tested on Site at time of Commissioning
0. Fully Type Tested . all tests detailed below completed and evidence attached to this submission		N/A	N/A	N/A
1. Operating Range	N/A			
2. PQ – Harmonics				
3. PQ – Voltage Fluctuation and Flicker				
4. Power Factor (PF)				
5. Frequency protection trip and ride through tests				
6. Voltage protection trip and ride through tests				
7. Protection – Loss of Mains Test, Vector Shift and RoCoF Stability Test				
8. LFSM-O Test				
9. Power Output with Falling Frequency Test				
10. Protection – Reconnection Timer				
11. Fault Level Contribution				

Common mistakes in the form can include Harmonic current calculations are incorrect; Fault level contribution missing; and Limited Frequency Sensitive Mode – Overfrequency (LFSM-O) active power output does not reduce in the required droop range.

Onsite Compliance Monitoring

For all onsite monitoring by the DNO, the Generator shall provide all relevant test signals as agreed with the DNO when compliance tests are being undertaken. Information on the signals each Generator should provide to the DNO and their resolution can be found in section 15.9 of EREC G99.

Power Quality Assessments

Power quality assessments are required, as per EREC G5 and EREC P28, in relation to harmonics and voltage fluctuations. Generation equipment should not result in harmonics exceeding recommended limits or significant variations in grid voltages outside the limits set out in EREC G5 and EREC P28 respectively. An assessment of compliance with EREC G5 and EREC P28 is necessary for Fully Type Tested devices < 50 kW, however this will generally allow the connection of a Fully Type Tested device with no need for mitigation (unless the fault level is unusually low, e.g., in remote rural locations). Fully Type Tested status cannot be obtained for power generating modules with a capacity > 50 kW, due to the need for site specific compliance assessments with EREC G5 and EREC P28.

Section 8.3: G99 Type B-D, The Connection Application Process

This section provides:

- Details of the key stages in the process of making a connection application and receiving a response from the DNO;
- Details of the information that you will need to provide to the DNO and the studies that they will need to carry out to assess your application;
- Information about what a Connection Offer typically contains; and
- Information on additional forms and notifications required by EREC G99.

Introduction

This section of the Guide describes how to make a connection application to a DNO. It focuses on some specific actions that you will need to take as part of the overall process of “Getting Connected”, which is described in Section 3 of the Guide.

Details of the connection application itself are provided, with reference to the ENA’s standard application form. The timescales involved in making a connection application are described, although these can vary significantly from one project to another.

This section also includes details of the type of technical studies which DNOs need to carry out, and the likely requirements they will have for data from you about the proposed generation project.

The Connection Application Timeline

The timeline shown on the next page is an indicative guide as to how long it might take you to have a Connection Offer agreed with your DNO. The information box in Page 110 summarises the licence obligations of the DNO to give you a Connection Offer within a particular time, once you have provided all the necessary data supporting your application.

The times shown in the timeline could vary depending on, for example:

- How quickly you are able to do the background work;
- How complex your connection is; and
- Any technical or planning issues that the DNO identifies.

For more information about the information needed by DNOs at different stages in the connection process, see the Distribution Data Registration Code in the Distribution Code. This is available from <https://dcode.org.uk/the-gb-distribution-code-review-panel.html>

Figure 11: Indicative connection application timeline.

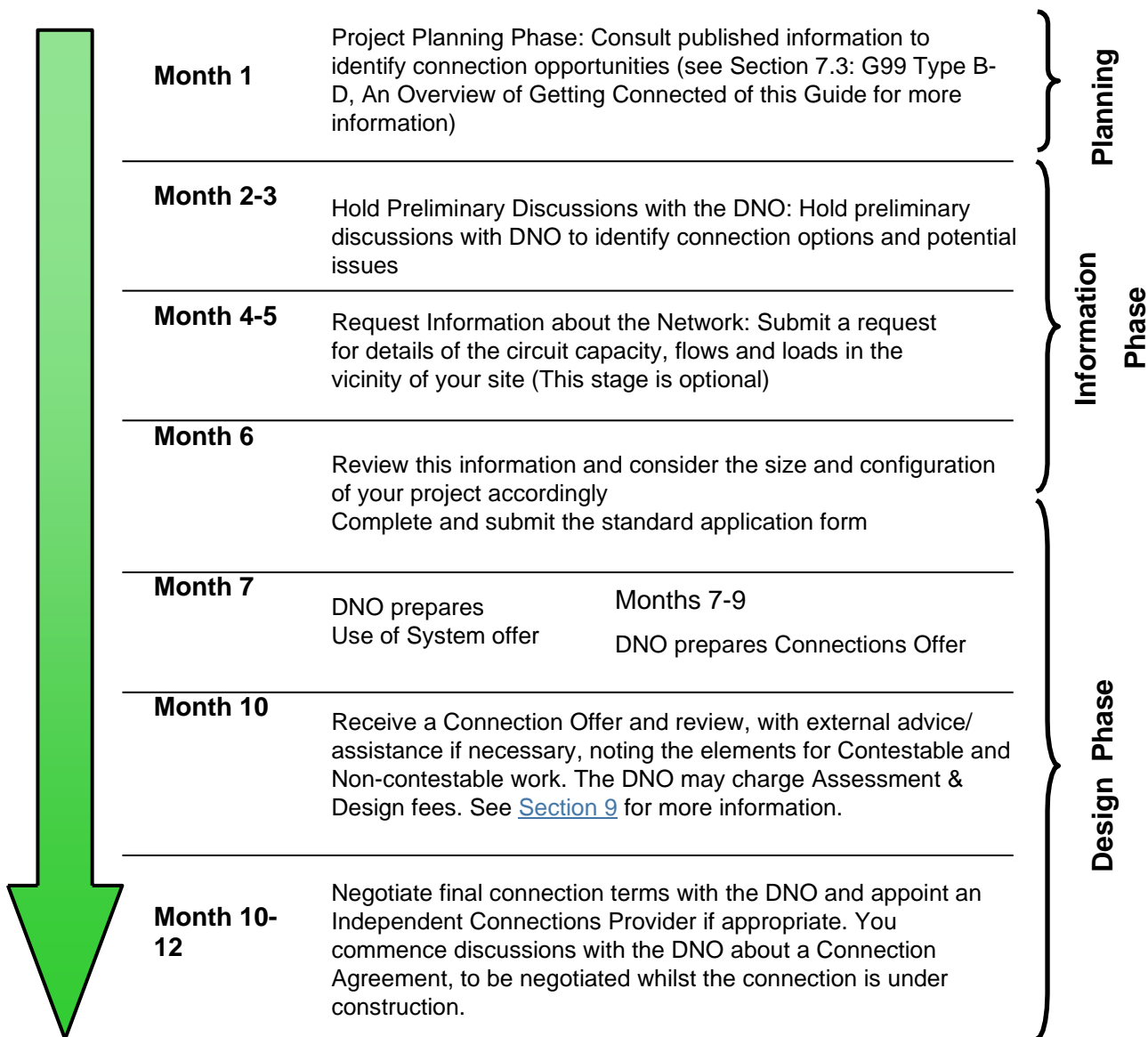

Notes on the Indicative Timeline:

Some of the stages shown in the timeline are optional, for example, consulting the published information and obtaining advice regarding preliminary connection designs. These activities can be useful as they provide extra information earlier in the process, and they may uncover issues earlier than they would otherwise be known, allowing them to be planned for. If you do not undertake these activities but are happy to lodge a formal connection application after an initial discussion with your DNO, the time to complete this process will be reduced.

It is also possible to combine some of the stages of activity, so that for example you begin compiling the information to support your connection application whilst in the early stages of discussions with the DNO. This would reduce the elapsed time in the connection process from what is shown above.

If your generation project might have an impact on the transmission system, the above timescale could be significantly extended, due to the need to obtain and Evaluation of Transmission Impact assessment form from NESO regarding any required transmission system modifications. You should discuss the likelihood of such an assessment being required with your DNO at an early stage.

Initial Discussions with the DNO

To make applying for a connection as straightforward as possible, you are advised to contact your DNO at an early stage in the connection process. You should explain to them in as much detail as you can the plans that you have in mind, so that they can give you an early indication of the likely technical challenges and/or significant cost items which may be required to make your connection possible. If you think you will have import requirements (most generation projects have a least a small import requirement to cater for when the Power Generating Facility is not running), these should be discussed with the DNO as well as your export capacity requirements. It is likely that the DNO will invite you for an initial discussion, which is usually free of charge. This is the chance for both parties to share information which will be helpful in putting the connection application together. Before you have this discussion, though, it's helpful if you have done some background work to investigate the network in the area around your project, and to be able to provide technical information about your generating equipment.

Information about the Network

To obtain more specific information, however, you can make a request to the DNO for an estimate of the present and future circuit capacity, forecast power flows and loadings on the relevant parts of the distribution system. You may be charged for some or all these services.

The information that the DNO will provide should be sufficient to enable you to identify and evaluate the opportunities for connecting to and using the relevant parts of the DNO's network. It may also, if you so request, include a commentary on the DNO's views regarding the suitability of the relevant part of the distribution system to accommodate new connections and the export of power from the proposed Power Generating Module(s).

You may also wish to request the DNO or a third party (e.g. an engineering consultant) to carry out feasibility studies to identify budgetary connection costs for your proposed project. The reliability of these estimates will be significantly influenced by the quality of the information that you can provide at this time to enable a reasonable assessment of the likely connection configuration and capacity to be carried out. Some DNOs will charge for carrying out these budget estimate and others will not.

Requesting information: This stage is not compulsory—you can proceed with your application form without carrying out this background work. It is up to each developer to decide whether requesting this sort of information is going to be helpful to the overall development of their connection, or whether simply to proceed with the formal application.

The Standard Application Form

You should use the standard application form (Connection of Power Generating Modules to DNO Distribution Networks in accordance with EREC G99). This is available on the [Energy Networks Association website](#).

The standard application form contains a comprehensive list of data requirements to assist the DNO with carrying out system studies. You should do your best to provide as much of this information as possible to ensure your quote is as accurate as it can be and to enable the DNO to assess your connection application promptly. If you have difficulty filling out this form, you can discuss this with your DNO or an adviser such as an engineering consultant. The requirements in the application form are based on the requirements of the Distribution Data Registration Code (DDRC), which is part of the Distribution Code. This splits the data requirements from Distributed Generation into three categories: Standard Planning Data, Detailed Planning Data and Operational Data.

The application form is split into five parts. Parts 1 to 3 ask for Standard Planning data, and Part 4 seeks detailed planning data. Parts 1-3 must be completed as part of the initial submission for Type A Power

Generating Modules; completion of Part 4 may be delayed but must be provided before synchronisation. Parts 1-4 must be completed as part of the initial submission for Types B, C and D Power Generating Modules. Part 5 enables you to provide additional data that may be required by the DNO before they issue a Final Operational Notification (FON). Your DNO will tell you if you need to provide this information.

The standard application form is used as an iterative document, developed as the connection and commission process develops, in conjunction with the PGMD. It is used to record information about your generating units that needs to be provided to the DNO before commissioning, to comply with the requirements set out in the Distribution Code DDRRC.

When completed, your application form should be sent to your DNO. Your DNO's contact details can be found on the [membership area](#) of the ENA website. An online application process may be available on your DNO's website.

Standard Application Form

Part 1 is for information about the Owner/Operator of the generation unit(s) and their consultant's details if applicable, as well as details about the facility, including its location.

Part 2 is for information about export and import arrangements.

Part 3 requests some information specific to the generating units that you are planning to use.

Part 4 requests detailed information about the generating units, including Electricity Storage that you are planning to use.

Part 5 requests more detailed information that is specific to the generation technology and equipment that you are planning to use. The information here is quite detailed, and, if your DNO asks you to provide this information, you may require assistance from the proposed suppliers of your generation equipment to fill in all of the details.

Network Studies

Once you have filled in and submitted the standard application form, the DNO will need to assess the impact of your Power Generating Module(s) on the distribution system. Your project may affect parts of the network that are distant (both geographically and electrically) from it, including at higher voltage levels (e.g. an 11kV connection can impact the 33kV network). It can take some time to identify the impact on the network at higher voltage levels. The DNO will carry out studies which may include:

- Load flow studies, to work out where the power that you generate will flow on the distribution system and to check that currents and voltages will stay within equipment ratings and statutory operating limits;
- Contingency analysis, to decide how to configure your connection so that you can continue to generate if one network component is not in service for any reason (eg. maintenance or work on the network, or a fault on a cable circuit);
- Fault level studies, to calculate how much current would flow out of your generating units in short circuit conditions and to make sure that the system could safely interrupt the higher fault currents on the network once your project is operational;
- Transient stability studies may be necessary to determine whether there are going to be specific protection requirements associated with your project; and
- Studies of disturbances such as harmonics and voltage flicker - correcting problems such as this could involve the connection of additional equipment and possibly increase connection costs.

The number and complexity of studies that have to be undertaken will vary depending on a number of factors. These include the type and size of your generating units, the complexity and use of the distribution system around your site, and the level of security you want for your connection. An indication of the charges for these studies can often be found in DNO documentation, such as the Long-Term Development Statement, or the Statement of Charging Methodology.

How quickly must the DNO give me a Connection Offer?

The Standard Conditions of the Electricity Distribution Licence require DNOs to offer terms for connection and use of system “as soon as is reasonably practicable” after receiving a request. If you have only asked for Use of System, the DNO must provide an offer within 28 days. If you have requested both Connection and Use of System, the DNO must give you an offer within three months. These times only apply once the DNO has all the information from you that it can reasonably ask for.

Estimated data: If actual data is not available at the time of completing an application form, you may provide a reasonable estimate of the actual data. You should indicate if data is estimated. Where estimated data is submitted to the DNO, and the final data is significantly different from the estimated data, this may affect the validity of the Connection Offer. It is therefore important that the information you provide is as complete and accurate as possible, and that you inform your DNO of any changes to the data as soon as you can.

The Connection Offer

The Connection Offer that you will receive from your DNO should include the following:

- Details of the equipment and works needed to connect your Power Generating Module(s) to the distribution system;
- Information about any works needed to extend or reinforce the distribution system, and potentially the transmission system, as a result of connecting your generating units to the network;
- Whether the Connection Offer is for a constrained or unconstrained connection;
- Information about the metering which the DNO may want to install at your site to measure energy exports for operational purposes; and
- Any special metering, communications or data processing equipment that may be needed at your site to ensure that you and the DNO can comply with any requirements under the Balancing and Settlement Code (which you’ll need to comply with if you have a Generation Licence. See [Section 8. The Connection Application: Generation Licensing](#) for more information).

The Connection Offer will contain the technical and commercial terms which will apply for the DNO to construct the connection and provide Use of System services. The Connection Offer will differentiate between Contestable work and Non-contestable work, if you requested this information.

The Connection Offer will also contain details of the costs which will apply if the DNO undertakes the Non-contestable and Contestable work. Further information about the way these costs are worked out is given in [Section 9: Costs and Charges](#).

Wayleaves for New Connections

Obtaining wayleaves, or the right of way for new lines and cables to connect your generating equipment to the distribution system, can be time consuming. Wayleaves are generally obtained by the DNO, although they could in some situations be obtained by an ICP.

To understand the wayleave requirements for your connection you should:

- Discuss at an early stage with your DNO whether there is a possibility that obtaining the necessary wayleaves could be contentious;
- Consider asking the DNO to investigate this in any feasibility studies you may ask them to undertake
- Ask the DNO to indicate in the Connection Offer whether your connection costs or timing could be affected by wayleaving and/or planning consent issues, and to itemise the costs included in the quotation for these components; and
- Ask the DNO to consider alternative routes for cables and/or overhead lines, if this could result in simpler planning and wayleaving processes, and to indicate the different connection costs and timescales that may result – for example, cabling along a public highway, whilst being potentially more expensive than an overhead line, may have fewer wayleaving complications than an overhead line

option. Similarly, if the DNO can avoid routes with complex rail or motorway crossings then obtaining wayleaves and developing the connection may be easier and less costly.

Connection Conditions

The DNO may include certain conditions or restrictions in order for the connection to be built. Your Connection Offer will include details of these, and if you need to know more information then you can discuss this with your DNO. You will have to agree to these conditions in order to accept the Connection Offer.

Curtailable or Flexible Connection Offers

The DNO will decide if a connection is viable by considering the worst case credible scenario for the distribution system. If the connection of your generation would cause equipment ratings or statutory limits to be exceeded, then the DNO would not allow the connection without addressing the issues identified. The DNO may decide that the best thing to do is to reinforce the existing network so that it can accommodate the new power flows. However, this could be prohibitively expensive for your project.

In these cases, or where the customer has requested, the DNO may offer a connection with certain restrictions, such as setting a maximum level for export, or restricting generation export under certain network conditions. This could involve entering into a specific commercial arrangement.

For connection applications received by the DNO, the DNO may offer a curtailable connection to allow a quicker connection to the network. This will include an agreement that your connection may be restricted at certain times until the required reinforcement of the distribution system has been completed. The amount of curtailment in the interim period will be measured and compared against a limit, established by an agreed methodology, above which the DNO will pay you compensation. The curtailment will cease after an agreed end date by which time the necessary network reinforcement should have been completed. See [Section 9: Costs and Charges](#) for more information.

Even with a standard Connection Agreement, in rare operational scenarios it may be necessary for the DNO to restrict the operation of a generator in order to, for example, maintain safety or power quality.

If NESO is involved in your project (e.g. if your DNO has requested an Evaluation of Transmission Impact from NESO to identify any transmission system works required), then they can impose conditions on your connection. Your DNO must ensure that NESO conditions are met before they allow connection.

Reactive Power Import / Export

The apparent power at any point on the network is the product of the voltage and current at that point. The apparent power is made up of two components, the active power and the reactive power. It is likely that active power is the electrical power you are more familiar with. It is measured in watts (W) and is the useful power that we import into our houses to run our electrical goods. However, there also needs to be a balance of reactive power on the network. It is the DNO's responsibility to ensure that the distribution system can cater for both real and reactive power. Your generating unit will be capable of controlling the amount of reactive power that it absorbs or produces. All Power Generating Modules need to comply with EREC G99 reactive power capability requirements. It may be possible to mitigate negative effects that your generator might have on the network (e.g. rise in system voltage) by controlling the amount of reactive power you produce or absorb. This may allow you to connect a higher capacity generator. You can discuss this option with your DNO.

Interactive Connection Applications

Sometimes the DNO may be considering your Connection Application alongside others which would have an impact on the same part of the distribution system. It may be the case where it is not possible to connect all of these projects, due to network constraints such as capacity. In this case all the relevant applications are referred to as "interactive" and are treated according to a common set of principles which have been adopted by all the DNOs. These principles normally apply to generator applications above 1 MVA capacity connected at 11 kV and above. DNOs will, though, apply the same principles in other cases as required.

Connection Applications are defined as “interactive” if offers are made which: make use of the same part of the current or planned future network; or

- Have an operational effect on that network; and
- Would affect the terms under which connection can be offered to one of the other parties.

The DNO will tell you in writing if your connection application is interactive, or becomes interactive, with one or more others. Affected parties will receive a ‘Notice of Interactivity’, which includes:

- A notice that your Connection Offers/ POC Offers are interactive;
- Your respective position in the Interactive Queue, determined by the date on which your Connection Application was received (assuming that the application form was complete with the information required by the DNO). An Interactive Connection Offer is conditional on those higher up the interactive queue not being accepted;
- The process for accepting Interactive Connection Offers; and
- The dates of the ‘Moratorium Period’ (usually 10 working days) after which you can accept the Interactive Connection Offer.

When the DNO receives an Interactive Connection Offer acceptance, they notify all other affected parties that their Connection Offers are withdrawn. You will then have the option to re-apply or choose to have your original application to be re-considered. In this case the DNO will issue a new Connection Offer. Connection Offers are still considered in the original order within the Interactive Queue.

Accepting a Connection Offer

You will have a defined period specified in your Connection Offer within which to accept the offer. This will typically be in the range 30- 90 days but is likely to be nearer 30 days if your Connection Application was defined as being “interactive”. Acceptance periods can vary across DNOs.

If yours was the first of a number of “interactive” applications, you will have priority over subsequent applicants who may receive offers during this time, and this will be explained in your Connection Offer. If you were a later applicant, your offer will indicate that for some of the validity period of the offer it is dependent on the decision of the prior applicant(s) on whether to proceed with their connection(s). Connection Offers will also specify the date on which they become unconditional (because the previous Connection Offer(s) have lapsed).

Connection Offers may also be withdrawn if the DNO feels that your project is not progressing at a reasonable rate. This may be measured by progress against milestones set out in your Connection Offer. This is to prevent spare capacity being ‘reserved’ for projects that in practice are not actually being built.

For more information about Connection Offers and Interactive Applications

All DNOs publish documents called their “Statement of Methodology and Basis of Charges for Connection” This sets out in detail the way that each DNO handles Connection Applications and the arrangements DNOs make for dealing with Interactive Applications. These documents are available from each of the DNOs’ websites.

EREC G99 Additional Forms

There are a number of forms or reports that are required to be completed and submitted to your DNO throughout the development of your connection. Some of these were- introduced in EREC G99, as required by the European Network Code Requirements for Generators. These include:

- Power Generating Module Document (PGMD, as discussed in Section 3);
- Results of simulation studies; and
- Installation and commissioning confirmation form.

The submission and review of the PGMD is likely to be an iterative process so it is useful to engage early with the DNO.

Simulation Studies

The requirement for simulation studies for Types B, C and D Power Generating Modules arises from the Requirements for Generators Network Code. You need to submit a report detailing the outcome of studies to demonstrate compliance with a number of technical requirements, such as fault ride through and fast fault current injection. Some studies are generic whilst others relate to the Connection Point and require DNO information. Refer to EREC G99 Annex B.4 for Type B Power Generating Modules and Annex C.7 for Type C and D Power Generating Modules for more information.

Only when the DNO deems it necessary to ensure system stability and security, appropriately detailed models of Type A (and Type B) Power Generating Modules and their control system will be requested. Table 17 shows the modelling information required depending on the Type of your Power Generating Module.

Table 17 List of information required for different EREC G99 PGM Types

Power Generating Module information	Type A	Type B	Type C	Type D
Detailed models	~	~	✓	✓
Control systems models	~	~	✓	✓
Simulation study results	✗	✓	✓	✓
Simulation models	✗	✗	✓	✓
Simple modelling information	✗	✓	✗	✗

✓ = always needed; ~ = only on request; ✗ = not required

Site Compliance and Commissioning Tests

You may need to demonstrate elements of compliance on site, which you can do at the time of commissioning. There are forms in EREC G99 called “Site Compliance and Commissioning test requirements”, which set out the format of recording the relevant test results. They are available in EREC G99 in:

- Annex B.2 [Form B2-2](#) for Type B Power Generating Modules; and
- Annex C.2 [Form C2-2](#) for Types C and D Power Generating Modules

These forms should be submitted to the DNO on the day of commissioning if the tests are witnessed by the DNO. Otherwise, the DNO should receive the results within 28 days of commissioning.

For all onsite monitoring by the DNO, the Generator shall provide all relevant test signals as agreed with the DNO when compliance tests are being undertaken. Information on the signals each Generator should provide to the DNO and their resolution can be found in section 15.8 of the EREC G99 document.

Note some energy conversion technologies in Form B tables relate to non-electricity energy storage conversion technologies that are no longer relevant and should not be included. Their number within the tables are retained, but their energy conversion technology is defined as being “not used”.

Installation and Commissioning Confirmation

Commissioning should take place once the installation and connection is complete (or in the case of a phased installation when each phase is complete). The tests and checks required for commissioning are described in section 15 of EREC G99.

The results of the commissioning should be recorded on the Installation and Commissioning Confirmation Form. This is included in EREC G99 in:

- [Annex B.3](#) for Type B Power Generating Modules, and
- [Annex C.3](#) for Types C and D Power Generating Modules

Note that Form C.3 includes two additional commissioning checks.

You or your installer should fill out this form and sign the declaration at the bottom.

There are two parts to the Installation and Commissioning Confirmation Form:

- Part 1 is required for the Power Generating Facility (ie all Power Generating Modules), and
- Part 2 is required for each Power Generating Module.

The forms should be submitted to the DNO on the day of commissioning if the tests are witnessed by the DNO. Otherwise, the DNO shall receive the results within 28 days of commissioning.

EREC G99 Notifications

The EU Network Code Requirement for Generators (RfG) introduces a requirement for formal notifications from the DNO.

Power Generating Module Types B and C

For Type B and Type C Power Generating Modules the only notification you will receive is a Final Operational Notification (FON). The DNO issues this, as part of the Connection Agreement, when they are satisfied that you have demonstrated compliance with EREC G99. Type B and Type C sites do not have permanent rights to operate until a FON is issued; however, the DNO may agree to the Power Generating Module operating in parallel and exporting energy into the DNO's network before all the commissioning tests have been completed and the FON issued.

An Interim Operational Notification (ION) is generally only relevant to the commissioning of a Type D Power Generating Module. However, in certain circumstances, it may be impractical to complete all the necessary testing to achieve Final Operational Notification (FON) when commissioning a Type B or Type C Power Generating Module. Therefore, the DNO and Generators, in relation to, Type B and Type C Power Generating Modules may agree to an interim operating regime whilst awaiting the completion of all the necessary tests and data submissions. In such cases, an ION may be issued allowing the interim export of energy for the Generator's commercial purposes at the discretion of the DNO. Please refer to clause 17.3.6 and 18.3.6 in EREC G99 for more information.

Power Generating Module Type D

If you are installing a Type D Power Generating Module there are additional notifications, you need to obtain. Before energising your internal network for the first time, you need an Energisation Operational Notification (EON). You obtain this from your DNO by:

- Providing updated information required in the standard application form (or the Distribution Code Distribution Data Registration Code schedules), and
- Notifying the DNO that your plant is ready to connect, at least 28 days before you wish to do so.

When you want to synchronise your Power Generating Module for the first time you need to obtain an Interim Operational Notification (ION). You obtain an ION by submitting a draft Power Generating Module Document (PGMD). The ION may impose limitations on the maximum allowed output of your plant.

The ION will be valid for a fixed period of time to allow the compliance and commissioning tests to be completed and any unresolved issues to be addressed. If necessary, the ION can be extended, but the maximum length of time that an ION can be used is 24 months.

If the issues remain unresolved after 24 months it will be necessary to obtain a derogation from Ofgem.

On resolution of any unresolved issues and formal submission of the completed final PGMD and appropriate installation and commissioning forms the DNO will issue a FON which will form part of the Connection Agreement.

If, following issue of an FON, the generating plant is found to be non-compliant with EREC G99 you should notify the DNO and where possible rectify the issue.

If the non-compliance is not resolved within 28 days then you should undertake an investigation in conjunction with the DNO to determine the cause of the non-compliance and identify a solution. If after 56 days of investigations the issue is not resolved then you will be issued with a Limited Operational Notification (LON). You can continue to operate the Power Generating Module during this period, taking account of the operational restrictions in the LON. The LON will also list the unresolved issues.

You may also be issued with a LON if you modify your plant in such a way as to result in a change of performance. You will need to submit new data and a PGMD to demonstrate compliance with EREC G99.

The LON can last for up to 12 months. After 12 months you, in conjunction with the DNO, must apply to Ofgem for a derogation in order to obtain a FON if you are unable to demonstrate full compliance with EREC G99.

If a derogation is not granted then you will not be able to continue to operate the Power Generating Module.

Section 8.4: G99 Type B-D, The Connection Application Process – Generation Licensing

This section provides:

- An introduction to generation licensing;
- A guide to licence requirements for generators;
- Information about how to apply for a licence;
- A guide to the interactions you may need to have with NESO; and
- Contact details if you need more information.

Introduction

Depending on the size of your generating project, you may need to apply for a Generation Licence. This section of the Guide explains how to determine whether your generating project requires a licence, and the process for obtaining a licence if you need one.

There are a number of issues regarding generation licensing which affect the relationships that you will have with other electricity sector organisations. In particular, if your Power Generating Facility exports more than 100 MW, and therefore automatically requires a licence, you will need to talk with Elexon and NESO about the implications of trading electricity in accordance with the Balancing and Settlement Code. This section of the Guide explains more about the relationship between developers of Distributed Generation and NESO and highlights the different agreements that you could be required to enter into.

Full details are provided about the sources of further information that you will need to help you with the licence application process.

Who Requires a Generation Licence?

Currently all generation projects with an export capacity of greater than 100 MW requires a Generation Licence. Generation between 50 MW and 100 MW export capacity may be given an exemption from the requirement to hold a licence, subject to applying to DESNZ for an exemption, and being granted one. You will not require a Generation Licence if your power station:

- Does not export more than 10 MW;
- Does not export more than 50 MW, provided your generating units have a combined declared net capacity of less than 100 MW (in simple terms declared net capacity is the maximum output of the generating units less the capacity consumed by the site, unless your energy source is either wind, solar, wave or tidal—see the information box below for further details); and
- Was connected to the network before 30th September 2000, and does not export more than 100 MW, or has never been subject to central despatch.

You can check the details of whether your Generating project is exempt from the need for a Generation Licence and find a full definition of declared net capacity by looking at the UK government document [Statutory Instrument 2001 No. 3270, The Electricity \(Class Exemptions from the Requirement for a Licence\) Order 2001](#).

Requirements for a Generation Licence

The conditions which are included in a Generation Licence include a number of requirements affecting the interaction of your generating equipment with the transmission system and distribution system, for example, if you have a Generation Licence you will have to:

- Comply with the sections of the Grid Code that apply to you;
- Comply with the Distribution Code;

- Comply with the Balancing and Settlement Code (BSC) and become a party to the Balancing and Settlement Code Framework Agreement;
- Offer terms for providing Ancillary Services to the System Operator, if asked to do so;
- Provide information to Ofgem as required;
- Avoid discriminating between potential buyers of the electricity you generate; and
- Advise NESO about the planned availability of your generating units in accordance with the requirements of the Grid Code.

Applying for a Generation Licence

To apply for a Generation Licence, you should look up the UK government document, Statutory Instrument 2008 No. 2376, The Electricity (Applications for Licences, Modifications of an Area and Extensions and Restrictions of Licences) Regulations 2008. This contains detailed information about how to make the application, including information about the costs of a Generation Licence.

Your application should be sent to Ofgem and needs to include the following key items of information:

- The name, address and full contact details of the company making the application;
- The date from which the licence is required and;
- Company registration details, including names of directors.

This information should be provided in a form similar to that shown in the Statutory Instrument. In its current form the Generation Licence application doesn't require you to provide specific information about the generating equipment itself. These details will be needed, however, at the point when you apply to become a party to the Balancing and Settlement Code (BSC).

To summarise, it's important early on in the connection application process to work out whether you will need a Generation Licence or not. This depends on the **size** of, and level of export from, your generating units. The licence application process is clearly defined in the legislative documents referenced at the end of this section. If you need help filling in the application, you should consult a legal or technical adviser who is familiar with generation project development.

National Energy System Operator Interfaces

If your Distributed Generation project involves developing a large power station, you will need to enter into an agreement with NESO, the System Operator of the GB electricity transmission system. This is because large power stations are likely to have an impact on the system at higher voltage levels than the distribution system. Power exports from Large Powers Stations could affect flows on the transmission system; in addition, large power stations can contribute to the balancing of the system as a whole. Because of this, if you're developing a large power station, you'll need to enter into a range of contracts with NESO and other parties.

The difference between the licence exemption limits described earlier and the technical definitions of large power stations gives rise to two different agreements which could apply to developers of Distributed Generation.

These are:

- the Bilateral Embedded Generation Agreement (BEGA) - an agreement between developers of power stations with a capacity of greater than 100MW and NESO. Generators are required under the terms of the BEGA to comply with the Connection and Use of System Code (CUSC), the Grid Code and the Balancing & Settlement Code. The BEGA gives the generator the right to export onto the GB transmission system and to operate in the energy balancing market. Developers of Small and Medium power stations have the option to enter into a BEGA if they wish to take part in the wholesale electricity market; and
- the Bilateral Embedded Licence Exemptible Large Power Station Agreement (BELLA) applies to large power stations which are exempt from having a Generation Licence. This agreement is only available to large power stations in Scotland, which could be below the 100 MW threshold at which holding a

Generation Licence is mandatory. The BELLA sets out the provisions for generators to comply with the CUSC and Grid Code. They cannot operate in the electricity balancing market, however, and are not therefore required to comply with the Balancing and Settlement Code (BSC).

Medium Power Stations that are exempt from holding a Generation Licence are known as Embedded Medium Power Stations in EREC G99, and are also sometimes known as 'Licence Exemptible Embedded Medium Power Stations' (LEEMPS). Although they do not have explicit access to the transmission system, the DNO may need to agree an updated Bilateral Connection Agreement with NESO which may impose conditions related to the generation. The DNO is likely to pass on any such obligations to the generator via the Connection Agreement.

If you have a BEGA with NESO, you are considered to be a user of the transmission system and are therefore liable to pay Transmission Network Use of System Charges.

If you do not have a BEGA you are not considered to be a user of the transmission system and you are not liable to pay Transmission Network Use of System Charges. However, you are not entitled to "use" the transmission system. In some circumstances this could limit the operation of Distributed Generation where the operator does not hold a BEGA.

You do not need to enter into an agreement with NESO if:

- You are developing a power station that has a capacity less than that of a Large Power Station (see below, and note the variation for England & Wales and Scotland); and
- You do not require access to the transmission system.

However, certain elements of the Grid Code will still apply to a medium power station. The sections that apply are set out in the Distribution Code. The [Guide to the Distribution Code](#) contains figures that illustrate the Grid Code and Distribution Code boundaries.

In summary, the interaction that you will have with NESO depends on where your generating project is located, its size and level of export. If you are developing a Large Power Station, even if it is connected to the distribution system, you are considered to be a user of the transmission system and will need to discuss which agreements you will require and possible network charges with NESO. You may also be subject to charges for reinforcement work required on the transmission system to accommodate your project, depending on the outcome of studies arranged by NESO.

Definition of a Large Power Stations

The definition of a Large Power Station varies between England & Wales and Scotland, due to the different transmission voltage levels and system characteristics in these regions. The Grid Code defines a Large Power Stations as having a registered capacity as follows:

- 100 MW or above in the National Grid Transmission system;
- 30 MW or above in the Scottish Power Transmission system; or
- 10 MW or above in the Scottish Hydroelectric Transmission system.

Responsibility for compliance assessments

When a Generators seek a bilateral contract with NESO (Bilateral Embedded Generating Agreements or BEGA), there is a need to be clear about which party is responsible to review the compliance evidence submitted by the Generator. The DNOs and NESO have agreed that the DNOs are responsible for the compliance assessment of all embedded Small and Medium Power Stations, whilst NESO is responsible for assessing compliance with the small number of Grid Code obligations which are not replicated in EREC G99.

The DNO will issue a FON once all compliance assessments required under the EREC G99 are completed. The Generator should then share this with NESO who then completes the compliance assessments against the Grid Code obligations. Once NESO has completed their assessment, NESO will issue a Final Balancing Completion Notice to the Generator.

More information about Transmission Charges

Full details of NESO's Transmission Network Use of System Charges are available on their [website](#).

Evaluation of Transmission Impact Assessment Process

If you are not developing a Large Power Station, i.e. you do not have an agreement with NESO (such as a BEGA or BELLA), then the DNO may still need to submit a request to NESO for an Evaluation of Transmission Impact assessment. They will do this if they believe that your generating unit(s) may have an impact on the transmission system. If you are developing a Large Power Station, then you will have discussions directly with NESO which will cover these issues.

The Evaluation of Transmission Impact Assessment process allows NESO, and the relevant Transmission Owner, to determine if any work is required on the transmission system to allow your connection to go ahead. NESO will inform your DNO of the resulting decision and give any details they need. Your Connection Offer may include details of any transmission system works are required along with securities and liabilities that you will need to provide for those works. You may also be required to comply with technical conditions relating to the transmission system, either as specified in the Grid Code, or the DNO's site specific Bilateral Connection Agreement with NESO.

NESO gives more information about the Evaluation of Transmission Impact assessment on their website, including a guidance document for small embedded generation.

The Statement of Works process is one of the three ways of undertaking a Evaluation of Transmission Impact assessment. Updates to NESO Statement of Works process can be found [here](#). In some cases, even relatively small generation projects can trigger this process. This may be because the transmission system is already close to its statutory limits or to the ratings of system equipment, and the addition of any generation, even if it is small, may be enough to exceed these limits.

The Evaluation of Transmission Impact assessment process can lead to significant additional costs if transmission work is required, and may impose timescale constraints on your project, which need to be carefully considered. In some cases, the Statement of Works process can take more than 3 years. There is more information on the Statement of Works process in [Section 9: Costs and Charges: Connection Costs](#).

Where to Find More Information

The following UK Statutory Instruments are relevant:

- For full details on Generation Licence exemptions: [Statutory Instrument 2001 No. 3270, The Electricity \(Class Exemptions from the Requirement for a Licence\) Order 2001](#).
- To apply for a Generation Licence, you should look up the UK government document: [Statutory Instrument 2008 No. 2376, The Electricity \(Applications for Licences, Modifications of an Area and Extensions and Restrictions of Licences\) Regulations 2008](#).
- We have referred to the following Codes in this section:
- The [Grid Code](#) and [Connection and Use of System Code \(CUSC\)](#) which are available on NESO's website;
- The [Distribution Code](#) is available on the Distribution Code website; and
- The [Balancing and Settlement Code \(BSC\)](#) is available on Elexon's website.

National Grid Electricity Transmission publishes information for new embedded (distributed) generation connections at: <https://www.nationalgrid.com/electricity-transmission/connections>

Getting Connected – Guidance on Compliance

ENA Type Test Register

The ENA has replaced the Type Test Register which closed on the 16th April 2024. As a result, all functionality and all held data has been migrated across to the [Connect Direct Portal](#). On Connect Direct, you are now able to register new devices, update existing devices and register new users / manufacturers. Connect Direct allows products to be registered with the ENA to be assessed and make them available.

This register is provided to allow anyone access to the Type Test Verification reports for products relating to electricity generation.

The manufacturer will need to complete a Type Test Verification Report, which demonstrates that the generating unit complies with EREC G98 or EREC G99 requirements. Once complete, the Type Test Verification Report should be uploaded and maintained on the Connect Direct portal by the generating unit manufacturer. Connect Direct gives assurance to DNOs and IDNOs that the generating unit connected to their network is fully compliant with EREC G98 or EREC G99 technical requirements. Connect Direct also gives assurance to customers and installers that equipment is suitable to be connected and operated in parallel with the distribution system. When details on a new generating unit, or amendments to an existing generating unit, are submitted to the portal, it is assigned an 'Awaiting Assessment' compliance status. It can take up to 4 weeks for the compliance status to be assessed. Once the ENA compliance assessment is complete, one of the following compliance statuses will be assigned:

- **Compliant:** The generating unit has been reviewed against EREC G98 or EREC G99 requirements and is deemed compliant. This is indicative only and the DNOs retain the right to review the suitability of connecting the generating unit to their network.
- **Minor Non-compliance or Document Error:** The generating unit cannot be accepted as being compliant due to documentation errors or the need for additional further information or assessment to ensure compliance with EREC G98 or EREC G99. Once the documentation has been updated by the manufacturer, it will be reviewed again.
- **Non-compliant:** The generating unit is deemed, based on the submitted evidence, or lack of it, to be non-compliant and requires a revision and update of the information. Non-compliant generation must not be connected in parallel with the network and manufacturers should update and resubmit their evidence to the ENA.

The ENA provides compliance guidance on the previous [Type Test Register website](#) to support manufacturers with:

- Providing the right information in their Type Test Verification Report; and
- Confirming compliance after the ENA's review of the evidence against EREC G98 or EREC G99 requirements.

Further guidance is provided on the Connect Direct Portal. Type Testing of Micro-generators and Power Generating Modules must stay up to date with the most recent EREC G98 and EREC G99 updates. Further information is detailed in the breakout box on Type Testing requirements on page 19 of this document.

Key information is summarised below:

- A PowerPoint webinar presented at a manufacturers' workshop on 03 November 2020. This provides an example walkthrough of the EREC G98 Form C (Type Test Verification Report) for a 3 kW Energy Storage Device, with tips on how to record the right information in the form. The webinar slides contain examples of compliance and non-compliance, including typical errors seen in Type Test Verification Reports. The PowerPoint slides can be accessed via the ENA Type Test Register: <https://www.ena-eng.org/gen-ttr/>;
- Further information on EREC G98/G99 application form guidance: https://www.ena-eng.org/gen-ttr/UserGuide/G98_G99_Guidance_Forms.pdf.

PGMD Iterations

The PGMD document contains a checklist of criteria which needs to be signed off by the DNO as part of the process of demonstrating compliance with the EREC G99 requirements. The PGMD is likely to be an iterative document developed between you and the DNO. Examples of the reasons for iterations and some issues to avoid include:

- DNOs are not able to open files you sent;
- Details on charts or schematic network diagrams are not legible (e.g. writing is too small);
- EREC G5 and EREC P28 assessments are not compliant with the latest versions of EREC G5 and EREC P28;
- Test results are not provided in accordance with EREC G99 requirements; and
- The equipment being modelled in the simulation studies is not the same as the one being installed.

Given the different nature of the requirements, and the fact that some requirements can be demonstrated early in your project and others towards the end, it is likely that you will submit different iterations of the PGMD documents at different times rather than a final PGMD at the end of the project. Once you send information to the DNO and they review it, they may ask for more details or clarification of the information submitted. To try to minimise the number of iterations of the PGMD between you and the DNO, some guidance is provided below as to what study results the DNO will expect to see included with your PGMD documents.

Compliance Studies

You should submit data at the initial submission stage to demonstrate compliance with:

- Reactive power;
- Fault ride through; and
- Frequency response.

To do this you should provide a report of the power system analysis that has been undertaken for your power generating facility. EREC G99 Annex B.4 and Annex C.7 detail the studies required. The study report should enable the DNO to fully understand the system under study, the data used, the studies undertaken, the study results and how the results of the studies demonstrate compliance with EREC G99. As a minimum DNOs would expect the study report to contain:

- A single line diagram of the Power Generating Facility, including any equivalent networks that have been used (for example to represent the demand of a facility);
- Confirmation that the Power Generating Module(s), transformer and storage data used in the Power Generating Facility model is the same as the data you provided in the standard application form at the application stage;
- A Power Generating Module or generating unit performance chart. This is a chart the manufacturer should provide showing the active power capability of the Power Generating Module in both leading and lagging reactive power modes for different power factors. A typical chart is shown below; and
- Representation of the distribution system beyond the point of connection – this should be set up to represent the short circuit power MVA and X/R ratio of the distribution system (maximum or minimum as applicable for the study). The DNO can provide this information.

Only when the DNO deems it necessary to ensure system stability and security, appropriately detailed models of Power Generating Modules and their control system will be requested. A table below has been developed to explain what may be required, where it is required vs not required depending on your G99 type.

Table 18 List of information required for different EREC G99 PGM Types

	Type A	Type B	Type C	Type D
Detailed models	~	~	✓	✓

Control systems models	~	~	✓	✓
Simulation study results:	✗	✓	✓	✓
Simulation models	✗	✗	✓	✓
Simply modelling information	✗	✓	✗	✗

✓ = always needed; ~ = only on request; ✗ = not required

Onsite Compliance Monitoring

For all onsite monitoring by the DNO, the Generator shall provide all relevant test signals as agreed with the DNO when compliance tests are being undertaken. Information on the signals each Generator should provide to the DNO and their resolution can be found in section 15.9 of EREC G99.

Figure 12: Typical chart provided by a manufacturer showing the active power capability of the Power Generating Module

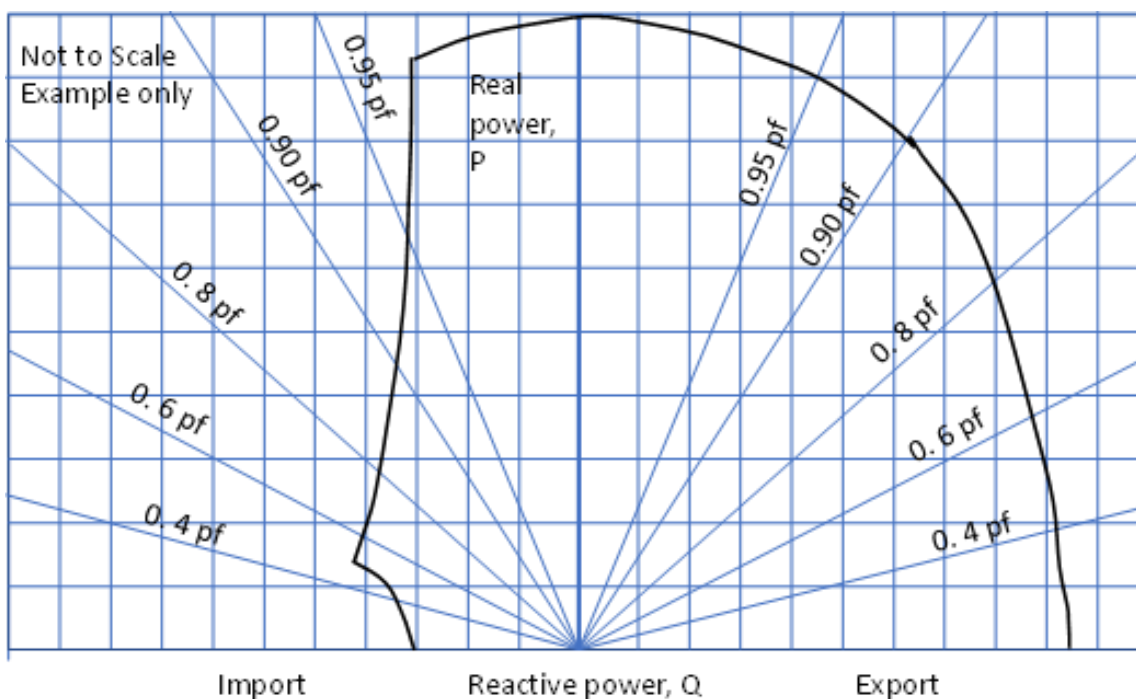

Reactive Capability across Voltage Range

The Power Generating Module must be capable of providing reactive power at the Connection Point in accordance with the requirements in EREC G99 for your Power Generating Module Type. A power system study of the Power Generating Facility should be undertaken to demonstrate reactive capability compliance. As a minimum the model should comprise the following items:

- The new Power Generating Module being connected (including the generating units that comprise the Power Generating Module);
- Any existing Power Generating Module(s);
- The network between the Power Generating Module and the Connection Point;
- The network between generating units; and

- Representation of the remaining facility as necessary (for example demand or compensation equipment that would affect the power factor).

A load flow study should be undertaken to demonstrate that the power factor range at the Connection Point is within the requirements of EREC G99.

- For Type B Power Generating Modules, this is at nominal voltage;
- For Type C and D Power Generating Modules, this is at nominal voltage plus 5% and nominal voltage minus 5%; and
- Studies should be undertaken at both the Registered Capacity of the PGM and the lowest power output that the Power Generating Module can stably operate at (minimum stable operating level).

In some cases, e.g. where a Power Generating Module is embedded within your installation and mainly meeting your demand, you and the DNO may agree that reactive power compliance is only necessary at the Power Generating Module terminals, rather than at the Connection Point. In this case:

- This may be recorded in your Connection Agreement; and
- A generator performance capability diagram should be sufficient to demonstrate reactive capability.

A simplified example of the required studies for Types C and D Power Generating Modules is given in the diagram below – refer to registered capacity examples in Appendix A.

Figure 13: Example of Type C and D PGM Reactive Capability Studies.

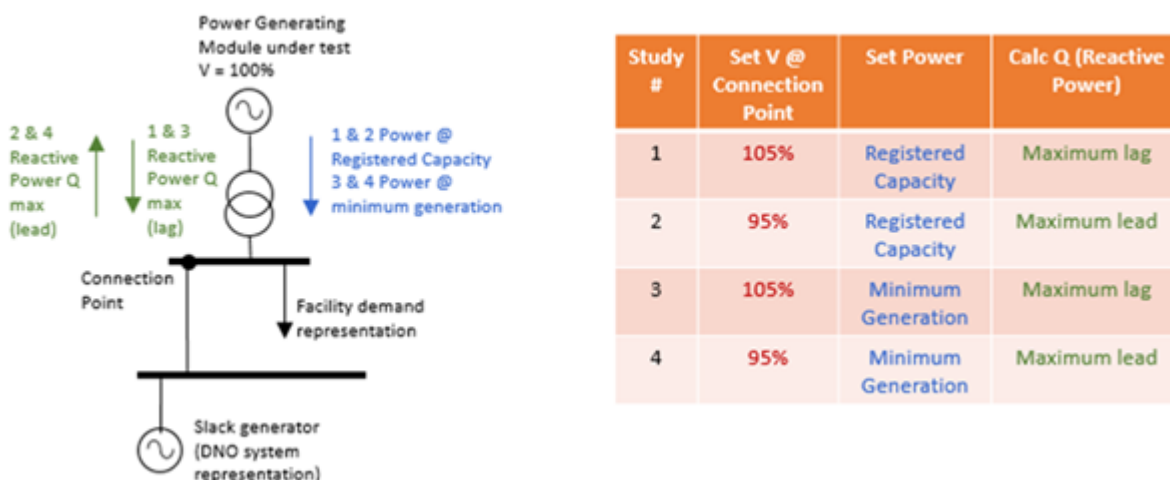

Fault Ride Through and Fast Fault Current Capability

In order to demonstrate compliance with Fault Ride Through requirements in EREC G99, simulation studies should be carried out for the following conditions:

- Three phase faults;
- Phase to phase fault;
- Two phase to earth fault; and
- Single phase to earth fault.

In all cases, the simulations should demonstrate that:

- In the event of a fault on the transmission system the generating units will support the system during the fault by increasing their reactive power injection to increase the system voltage; and

- After the fault has been cleared by the protection the voltage and active power will recover.

Time series simulation studies, where a fault is applied for 140 ms should be undertaken for the four study conditions shown in Figure 14. As an example, for a Type B Power Generating Module, the simulated fault should cause the voltage to fall by 70% for synchronous Power Generating Module or by 90% for Power Park Modules. This is different for Type C and D for Power Park Modules depending on voltage at the Connection Point and whether you are connecting a synchronous Power Generating Module or a Power Park Module. The study should demonstrate that the recovery of the voltage at the Connection Point should be within the acceptable envelope as detailed in EREC G99. A simplified example of the required studies for a Type B Power Generating Module is given in the diagram below, Figure 14.

Fast fault current injection studies are also required for Power Park Modules. This is where a Power Park Module supports the system for up to 140 ms if there is a fault on the transmission system by injecting reactive current. The study should demonstrate that the injection of reactive power at the Connection Point should be within the acceptable range as detailed in EREC G99.

Figure 14: Example of Type B PGM Fault Ride Through and Fast Fault Current Injection Studies.



Frequency Studies

In order to demonstrate compliance with the frequency response requirements, simulation studies should be carried out to demonstrate the over and under frequency response (as applicable to your Power Generating Module). The studies can be undertaken by modelling the injection of a frequency signal (ramp or step) into the governor or controller model. For Limited Frequency Sensitive Mode – Over frequency (LFSM-O) when the frequency increases the Power Generating Module should respond by reducing active power. The response, which will depend on the droop setting, should start when the frequency reaches 50.4 Hz unless you have contracted with NESO to operate in frequency sensitive mode. This requirement is applicable to Type B, Type C and Type D Power Generating Modules. For Limited Frequency Sensitive Mode – Under frequency (LFSM-U) when the frequency decreases the Power Generating Module should respond by increasing active power. This requirement is applicable to Type C and Type D Power Generating Modules. The initial operating condition

should be that the Power Generating Module is generating at 80% of its capacity. The response, which will depend on the droop setting, should start when the frequency reaches 49.5 Hz unless you have contracted with NESO to operate in frequency sensitive mode. The studies you submit as part of the PGMD should demonstrate this response according to the Power Generating Module droop setting and in line with the EREC G99 frequency requirements.

Validation Studies

The generator, governor or frequency controller models and the excitation model should be validated against physical test results. It is expected that this would be undertaken by the Power Generating Module manufacturer, but this could be done after site tests, if required.

Providing Simulation Models

If your Power Generating Module is Type C or D, you will need to provide the DNO with the validated simulation models used in your simulation studies. The DNO will normally ask for this in a format that is compatible with the power system analysis software that they use – check this with your DNO. Some manufacturers provide “blackbox” models. This is where the model gives the correct outputs, but the internal workings of the model are not transparent to the user. Manufacturers do this to protect their intellectual property. You can provide these to the DNO or the manufacturer might provide this directly to the DNO, but be aware that the DNO will want assurance from the manufacturer that the model correctly represents the equipment in power system studies and what you are proposing to install. The DNO might ask for guidance on “black box” models, or study cases and scenarios.

Section 9: G99 Costs and Charges

This section introduces the rules around connection costs and ongoing costs to facilitate and manage new connections onto the distribution system for G99 generation units.

Section 9.1: G99 Type A, Costs and Charges

Introduction

There are two categories of charges made by the DNO:

- **Connection charge:** this is a one-off charge made by the DNO, which primarily covers the cost of work and equipment associated with connecting your generating project to the distribution system. This may include a portion of any reinforcement costs; and
- **Use of System charges:** these are ongoing charges, which primarily cover operation and maintenance costs and include the costs of ongoing network development including general reinforcement.

DNOs are obliged to publish documents describing the basis of their connection charges and their charging methodology. They also present the different elements of connection charges, and indicative costs for works and equipment of significant cost. This will help you to understand the charges they quote you.

This information is contained in the DNOs Statement of Methodology and Charges for Connection to the electricity distribution system. All DNOs' statements follow the same format and are available on their websites. These statements contain:

- The DNO's connection charging methodology (i.e. how they calculate their charges);
- The DNO's connection charging statement (i.e. what the charges are);
- An indication of the costs of providing a connection quotation / budget estimate; and
- Other relevant information for connecting customers.

The basis and elements of connection charges, as well as indicative costs and examples are discussed in this section of the Guide.

Use of System charges are levied by the DNO on the supplier, so as a generator you will not be charged these directly. However, this section is included for your information, as Use of System charges may appear as an item on your bill.

Connection Charges – Infrastructure

The connection provides an electrical path between your generation installation and the distribution system. Any work required to establish this connection will result in some initial costs, which will be charged to you upfront as part of the connection charge.

The work required to provide this path can be broken down into two categories:

- **New infrastructure (or extension assets)** must be installed to provide an extension of the distribution system. This is from the point of connection on the existing network up to the new point of supply; and
- **Some reinforcement of the existing distribution system infrastructure** may be required to accommodate your planned generation capacity.

These two categories are illustrated in Figure 15 below and the Point of Connection is defined in the Glossary.

Reinforcement work may be required to increase the electrical capacity of the distribution system that is close to your point of supply. However, some reinforcement work may not fit this description, for example:

- It may be necessary to replace existing or install new switchgear at a substation some distance from your project site. This could be due to the increase in fault level caused by the connection of your generating unit, or to create a new protection zone; or
- Equipment such as reactors or static VAR compensators may be needed for times when the voltage may rise, e.g. When your generating unit is exporting at times of light demand.

The asset costs that are included in the connection charge include:

- Costs associated with any extension to the network; and
- A portion of any reinforcement costs.

DNOs are obliged to publish a Statement of Methodology and Charges for Connection to the electricity distribution system a document which describing the basis of their connection charges and their charging methodology. You can refer to this document to see what portion of reinforcement costs you will be charged for. These are available on DNO websites.

Figure 15: Illustration showing network extension assets and reinforcement assets.

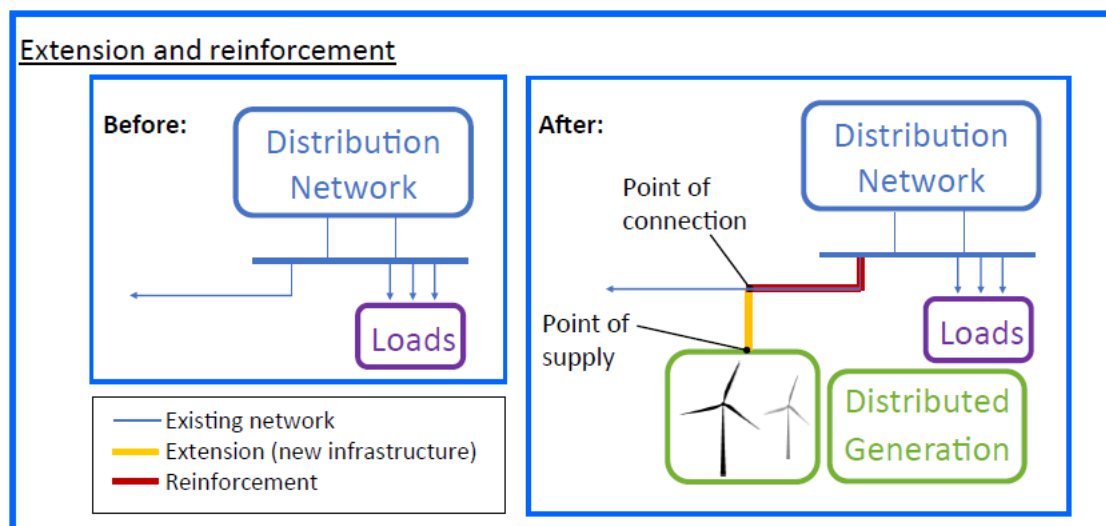

In some cases, Distributed Generation may have an impact on the transmission system. In this case your DNO may need to request an Evaluation of Transmission Impact assessment from NESO.

Connection Charges – Other Elements

Elements of Charges

As well as charges for any network extension or system reinforcement (if required), there are other elements that are covered in the connection charge. These can include the following:

- System / feasibility / fault level studies;
- Provision of wayleaves;
- Additional meetings with the DNO or site visits; and
- Administration.

Note that not all DNOs apply charges for all of these items, and that not all of these items may be relevant for your project.

Indicative Costs and Examples

Equipment costs and charges for services vary across DNOs; it could therefore be misleading to list indicative costs in this Guide. If you want to get an idea for indicative costs, the best place to look is the DNO's Statement of Methodology and Charges for Connection. You can find this on the DNO's website.

Aside from giving indicative costs for connection charges, these documents typically contain other useful information, including guidance on the connection process and examples of various connections and their associated cost breakdown. It is updated annually.

The connection charging methodology is governed by the Distribution Connection and Use of System Agreement (DCUSA) and is subject to open governance so any party materially affected by it can propose a change to it. The process for doing this is laid out within the DCUSA itself. See the DCUSA website for more information: <https://www.dcusa.co.uk/dcusa-document/>

The Distribution Charging Methodologies Forum exists to enable parties to discuss ideas for improving the methodology possibly prior to submitting a formal change proposal.

Estimating Costs and Getting a Quotation

As mentioned above, you can obtain indicative costs for works and equipment from DNO documents. To obtain a more accurate picture of the connection costs for your project, you can:

- Ask the DNO for a budget estimate; or
- Obtain an estimate of connection costs from a specialist engineering consultant.

You should exercise care in interpreting budget estimates. DNOs use reasonable endeavours to identify remote reinforcement costs associated with the proposed connection at this stage. However, it is possible that not all of the reinforcement costs will be included at this time.

Payment of Connection Charges

Connection charges are paid either:

- In full at the time that the Connection Offer is accepted; or
- In staged or phased payments, as per a payment schedule.

Staged payments are typically used for generation projects which are greater than a certain size, e.g. in project value or duration. The staged payments are generally intended to cover committed expenditure by the DNO.

If your connection does not proceed, it is possible that some of the connection charge will be refundable depending on whether the DNO has carried out any work. You should inform your DNO as soon as possible if you decide not to go ahead with your project.

Charging Futures Forum: The Charging Futures Forum is a programme that co-ordinates significant reform of electricity network access and electricity network charging arrangements. Ofgem is the chair of the programme, and members include generators, network operators, large customers, industry bodies and universities. The programme holds a quarterly forum and teams, called Task Forces, are formed to review specific issues in detail. For more information see the [Charging Futures Forum](#) website.

What is a Budget Estimate?

You may read about budget or indicative estimates and formal quotations. The differences between these two terms are summarised in the following table.

Table 19: Difference between Budget or Indicative Estimates and Formal Quotations.

Budget or Indicative estimate	Formal quotation
Requested in the early stage of a project, and generally, only for larger capital schemes	Requested when electrical requirements have been finalised
The DNO doesn't require much information from you	The DNO requires a lot of information from you
Based on a desktop study—the DNO is unlikely to carry out detailed designs or studies	Based on detailed design work, and may require other input such as site surveys
To give an indication of costs, and is therefore subject to change	Provides formal contract offer
Not open for acceptance	Open to acceptance, subject to conditions

Assuming that you ask the DNO to undertake all of the work involved in your connection, the timescale for the DNO to provide a budget estimate is 10 working days.

Connection Offer expenses (Assessment and Design fees)

Following a government consultation, DESNZ is now allowing DNOs to charge Connection Offer expenses (also known as Assessment and Design fees), regardless of whether or not the subsequent Connection Offer is accepted. Connection Offer expenses are a charge by the DNO for the cost of producing Connection Offers, and cover activities such as network modelling, connection design and site surveys. These changes came into force in April 2018. For further information refer to the [DESNZ website](#).

Note that DNOs apply these charges differently. For example, some are only applying them to projects with certain connection voltages. Refer to your DNO website for details on how they are applying the charges.

Use of System Charges

Use of System (UoS) charges cover operation, repair and maintenance of network assets, and also any reinforcement to the network that might be necessary that is not covered by the connection charge.

All generators with equipment connected at LV and HV are subject to UoS charges under the Common Distribution Charging Methodology (CDCM). Generators with equipment connected at EHV are subject to UoS charges under the EHV Distribution Charging Methodology (EDCM).

These charges can be negative for generation (i.e., credits). Please see the table below for definitions of the terms LV, HV and EHV.

DNOs are obliged to publish documents about their UoS charges. These cover their UoS charging methodology and a statement of what the charges are for both generation and demand customers. You can find these on DNOs' websites.

You can find out more about the Common Distribution Charging Methodology (CDCM) and EHV Distribution Charging Methodology (EDCM) from DNOs' websites and [Charging Arrangements](#) section on Ofgem website.

Distribution Use of System charges were subject to two of Ofgem's Significant Code Reviews – the Targeted Charging Review (TCR) and the Access and forward-looking charges review. For more information see [Section 9.3](#)

Definitions of LV, HV and EHV:

Term	Voltage level
LV (Low Voltage)	In general: less than 1 kV. In practice, this means 400/230 V
HV (High Voltage)	In general: 1 kV—22 kV. In practice, this means 6.6, 11 or 20 kV.
EHV (Extra High Voltage)	In general, this covers connection to the distribution system at or above 22 kV. In practice this means 33 or 66 kV, (or 132 kV in England and Wales only). Some DNOs may define this slightly differently. See the definition of EHV for your local DNO.

Metering Requirements, Parties and Charges

Metering requirements

You may require separate meters for measuring your import and export. There are two categories of meters:

- Half Hourly (HH); and
- Non-Half Hourly (NHH)

They are described in the information box on the next page.

The type of meter will affect:

- The meter charges you pay; and
- The category of UoS charges that apply.

Section L of the Balancing and Settlement Code (BSC) dictates the type of meter you will require. If you are classed as a 'Small Scale Third Party Generating Plant' (currently defined as less than 30 kW capacity), you can choose to have a NHH meter. Otherwise, you have to have a HH meter, if the export is to be metered. HH meters provide metering data for each half hour period, and so can be useful for understanding your electricity import or export at different times of the day. However, they have significant costs associated with them.

Parties Involved

Provision of NHH meters is the responsibility of the supplier. They will appoint the following Supplier Agents:

- A Meter Operator who installs and maintains the meter;
- A Data Collector who retrieves the data recorded by the meter and calculates your actual or estimated volume of energy consumption; and
- A Data Aggregator who sums up volumes of energy consumed for each supplier and sends the information to a central system for balancing and settlement

You can choose to contact your supplier about the provision of meters, or contract directly with a Meter Operator. If you use HH metering, it is your responsibility to appoint a Meter Operator. You will have to enter into a Meter Operator contract with a meter supplier. The contracts normally last for five years, and the Meter Operator will:

- Provide, install and maintain your HH meter; and
- Collect data from your HH meter via a communications link such as a telephone line.

The provision of meters is open to competition. Details of Meter Operators and their contact details can be found on the Association of Meter Operators website: <https://meteroperators.org.uk/>. There are Codes of Practice which detail technical requirements for Metering Systems. These can be found on [Elexon's website](#).

Charges

The cost of Meter Operator agreements and the costs associated with the communication to collect data from your meter can be in the order of several hundred pounds a year. You should consider obtaining quotations from a number of Meter Operators.

Note: in practice suppliers may pay the owner of some smaller Distributed Generation a fixed amount (e.g. £/year) instead of installing meters and making payments based on units exported, however this is not permitted when the installed meter has the capability to record and import and export separately.

Half Hourly (HH) meters and Non-Half Hourly (NHH) meters

Meters record the flow of electricity. There are two main categories of meters; Half Hourly (HH) and Non-Half Hourly (NHH). HH meters are for larger customers; if your generation peak power is greater than 30 kW you have to use a HH meter, if metering export.

NHH meters record total energy passing through the meter, but do not record the times the energy is transferred. Typically, the recorded data would be collected a few times a year, eg. every quarter. In contrast, HH meters measure and record energy passing through the meter for each half hour period. The data they record is typically collected remotely every day, for example by a telephone line.

Domestic customers are being encouraged to have a smart meter installed. Smart meters record total energy passing through the meter.. The introduction of smart meters should improve consumer awareness of energy consumption and will allow for the introduction of time of use tariffs.

Data from meters is used to determine charges and rewards. For example, to calculate imbalance charges for balancing and settlement, Distribution or Transmission UoS charges and Renewables Obligations Certificate rewards.

Section 9.2: G99 Type B-D, Costs and Charges

This section provides:

- An introduction to connection costs
- The basis of DNO connection charges for infrastructure
- A description of other elements of connection charges and where to find indicative costs and examples; and
- A summary of National Energy System Operator (NESO) connection charges and the Statement of Works process.

Introduction

There are two categories of charges made by the DNO:

- **Connection charge:** this is a one-off charge made by the DNO, which primarily covers the cost of work and equipment associated with connecting your generating project to the distribution system. This includes a portion of reinforcement costs; and
- **Use of System charges:** these are ongoing charges, which primarily cover operation and maintenance costs and include an element to cover the costs of ongoing network development including general reinforcement.

DNOs are obliged to publish documents describing the basis of their connection charges and their charging methodology. They also present the different elements of connection charges, and indicative costs for works and equipment of significant cost. This will help you to understand the charges they quote you.

This information is contained in the DNOs Statement of Methodology and Charges for Connection to the electricity distribution system. All DNOs' statements follow the same format and are available on their websites. This document contains:

- The DNO's connection charging methodology (i.e., how they calculate their charges);
- The DNO's connection charging statement (i.e., what the charges are);
- An indication of the costs of providing a connection quotation / budget estimate; and
- Other relevant information for connecting customers.

The basis and elements of connection charges, as well as indicative costs and examples are discussed in this section.

Connection Charges – Infrastructure

The connection provides an electrical path between your generation installation and the distribution system. Any work required to establish this connection will result in some initial costs, which will be charged to you upfront as part of the connection charge.

The work required to provide this path can be broken down into two categories:

- New infrastructure (or extension assets) must be installed to provide an extension of the existing distribution system. This is from the point of connection on the existing network up to the new point of supply; and
- Some reinforcement of the existing distribution system infrastructure may be required to accommodate your planned generation capacity.

These two categories are illustrated in Figure 16 below and the Point of Connection is defined in the Glossary.

Reinforcement work may be required to increase the electrical capacity of the distribution system that is close to your point of supply. However, some reinforcement work may not fit this description, for example:

- It may be necessary to replace existing or install new switchgear at a substation some distance from your project site. This could be due to the increase in fault level caused by the connection of your generating unit, or to create a new protection zone; or
- Equipment such as reactors or static VAR compensators may be needed for times when the voltage may rise, e.g. When your generating unit is exporting at times of light demand.

The asset costs that are included in the connection charge include:

- Costs associated with any extension to the network; and
- A portion of any reinforcement costs.

DNOs are obliged to publish a Statement of Methodology and Charges for Connection to the electricity distribution system a document which describing the basis of their connection charges and their charging methodology. You can refer to this document to see what portion of reinforcement costs you will be charged for. These are available on DNO websites.

Figure 16: Illustration showing network extension assets and reinforcement assets.

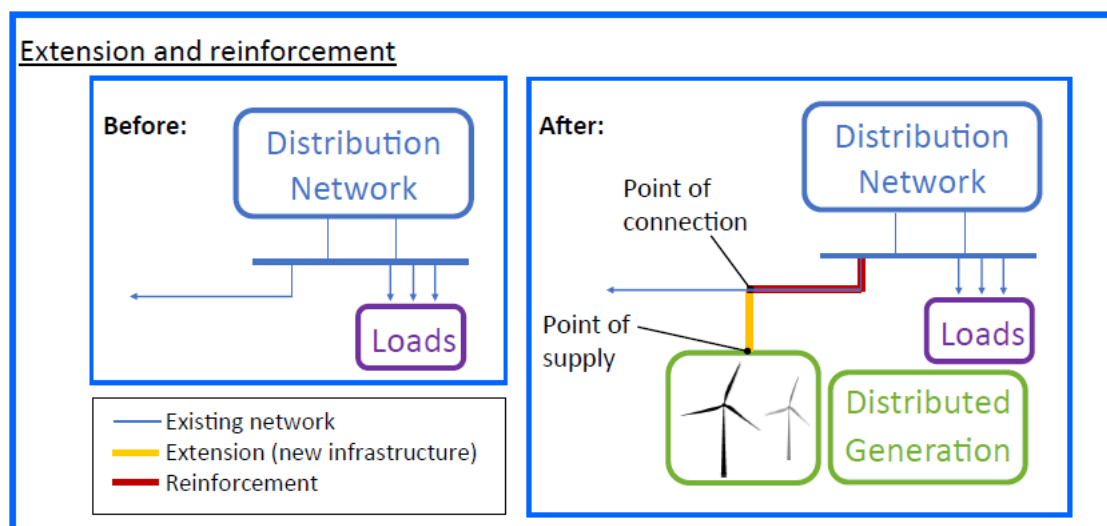

In some cases, Distributed Generation may have an impact on the transmission system. In this case your DNO may need to request an Evaluation of Transmission Impact assessment from NESO.

Connection Charges – Other Elements

Elements of Charges

As well as charges for any network extension or system reinforcement (if required), there are other elements that are covered in the connection charge. These can include charges associated the following:

- System / feasibility / fault level studies;
- Where work has been undertaken by an ICP, design approval, inspection, and monitoring of work
- Witnessing tests;
- Determining or providing information on point of connection;
- Additional meetings with the DNO or site visits;
- Administration, provision of wayleaves, NESO fees e.g. application for Statement of Works; and
- Substation locks and notices.

Note that not all DNOs apply charges for all of these items, and that not all of these items may be relevant for your project.

Indicative Costs and Examples

Equipment costs and charges for services vary across DNOs; it could therefore be misleading to list indicative costs in this Guide. If you want to get an idea for indicative costs, the best place to look is the DNO's Statement of Methodology and Charges for Connection. You can find this on the DNO's website.

Aside from giving indicative costs for connection charges, these documents typically contain other useful information, including guidance on the connection process and the breakdown of Contestable and Non-contestable work. The Statement of Methodology and Charges for Connection document also gives examples of various connections and their associated cost breakdown. It is updated annually.

The connection charging methodology is governed by the Distribution Connection and Use of System Agreement (DCUSA) and is subject to open governance so any party materially affected by it can propose a change to it. The process for doing this is laid out within the DCUSA itself. See the DCUSA website for more information: <https://www.dcusa.co.uk/dcusa-document/>

The Distribution Charging Methodologies Forum exists to enable parties to discuss ideas for improving the methodology possibly prior to submitting a formal change proposal.

Connection Offer expenses (Assessment and Design fees)

Following a government consultation, DESNZ is now allowing DNOs to charge Connection Offer expenses (also known as Assessment and Design fees), regardless of whether or not the subsequent Connection Offer is accepted. Connection Offer expenses are a charge by the DNO for the cost of producing Connection Offers, and cover activities such as network modelling, connection design and site surveys. These changes came into force in April 2018. For further information refer to the [DESNZ website](#).

Note that DNOs apply these charges differently. For example, some are only applying them to projects with certain connection voltages. Refer to your DNO website for details on how they apply the charges.

Estimating Costs and Getting a Quotation

To obtain a more accurate picture of the connection costs for your project, you can:

- Ask the DNO for a budget estimate; or
- Obtain an estimate of connection costs from a specialist engineering consultant.

You should exercise care in interpreting budget estimates:

- Normally they only cover the cost of the infrastructure on the DNO's side of the point of supply. There can be significant costs associated with the infrastructure on your side of the point of supply; and
- DNOs use reasonable endeavours to identify remote reinforcement costs associated with the proposed connection at this stage. However, it is possible that not all of the reinforcement costs will be included at this time.

For more information on budget estimates, see Table 20 below. You should consider the costs on both sides of the point of supply when evaluating your connection options. For example, the DNO might indicate that the connection costs would be lower if they were to provide a supply at 33 kV instead of 11 kV. But this option might require you to install and operate a 33 kV/11 kV transformer, in which case you would have to consider the cost of the transformer against the lower DNO costs.

Payment of Connection Charges

Connection charges are paid either:

- In full at the time that the Connection Offer is accepted; or
- In staged or phased payments, as per a payment schedule.

Staged payments are typically used for generation projects which are greater than a certain size, e.g. in project value or duration. The staged payments are generally intended to cover committed expenditure by the DNO.

If your connection does not proceed, it is possible that some of the connection charge will be refundable depending on if the DNO has carried out any work. You should inform your DNO as soon as possible if you decide not to go ahead with your project.

Charging Futures Forum: The Charging Futures Forum is a programme that co-ordinates significant reform of electricity network access and electricity network charging arrangements. Ofgem is the chair of the programme, and members include generators, network operators, large customers, industry bodies and universities. The programme holds a quarterly forum and teams, called Task Forces, are formed to review specific issues in detail. For more information see the [Charging Futures Forum](#) website.

What is a Budget Estimate?

You may read about budget or indicative estimates and formal quotations. The differences between these two terms are summarised in the following table.

Table 20: Difference between Budget or Indicative and Formal quotation.

Budget or Indicative estimate	Formal quotation
Requested in the early stage of a project, and generally, only for larger capital schemes	Requested when electrical requirements have been finalised
The DNO doesn't require much information from you	The DNO requires a lot of information from you
Based on a desktop study—the DNO is unlikely to carry out detailed designs or studies	Based on detailed design work, and may require other input such as site surveys

To give an indication of costs, and is therefore subject to change	Provides formal contract offer
Not open for acceptance	Open to acceptance, subject to conditions
DNO may charge	DNO will not charge

The Distributed Generation performance standard, introduced by the Distributed Generation standards directive, defines time periods within which DNOs should respond to a request for a budget estimate. This applies to Section 16 Applications (i.e. if you are applying to the DNO to undertake both the Contestable and Non-contestable elements of the connection work). The timescales for the DNO to provide a budget estimate are:

- 10 working days for connections of less than 1 MVA; and
- 20 working days for connections of 1 MVA or more.

The timescales for formal quotations are given in the information boxes in [Section 3.5: Design Phase](#).

Transmission Connection Charges

In some cases, Distributed Generation may have an effect on the transmission system. NESO may need to carry out studies to assess whether the impact of your project on the transmission system is significant. This is more likely if the project is large.

Fault Level

Fault level is a measure of the current which would occur in the event of a solid 3-phase short circuit at a certain point on an electricity network. Fault level is normally expressed in thousands of amps (kA) or the equivalent apparent power (MVA). It may be given as a range of values, as it can change over time. This can be due to changes in the network configuration to allow routine maintenance or isolate faults. The rating of existing circuit breakers and circuits place an upper limit on the range of fault levels that can be permitted in a particular part of the network. Your generating units can contribute to fault current, so it increases the fault level on the network. If connecting your generating unit increases the fault level above the capability of equipment on the distribution system or transmission system, you may have to contribute to reinforcements.

Evaluation of Transmission Impact

Section 6.5 of the CUSC sets out the obligations on a DNO in relation to assessing the impact that a Distributed Generation project might have on the transmission system. There are two main approaches:

- Statement of Works Process
- Transmission Impact Assessment (TIA)

Statement of Works Process

The Statement of Works process was the only means of establishing what, if any, work needed to be carried out on the transmission system as a consequence of connection your Distributed Generation.

If a Statement of Works is requested by the DNO, the relevant Transmission Owner will initial undertake studies to assess the impact of your generation on the transmission system. If your project does not have a significant impact, the process is complete.

There is an application fee for the request for Statement of Works. This fee depends on your geographical location.

If your project has a significant impact, the relevant Transmission Owner may need to:

- Undertake works on the transmission system or at a grid supply point; and
- Set specific requirements at your connection site.

The Statement of Works process helps identify whether there is a need to carry out reinforcement works on the transmission system as a result of a new Distributed Generation project (which includes electricity storage projects). NESO may impose conditions on the DNO regarding the Distributed Generation connection. These conditions are typically captured in the Connection Agreement between you and the DNO, and in any bilateral agreement you may have with NESO. Throughout this process, you would not have had any direct contact with NESO, unless you applied for a BEGA, and this process was handled by your DNO. The timescales for this process are prescribed in the CUSC. These may impose timescale constraints on your project.

Transmission Impact Assessment (TIA)

In recent years, the volume of applications for connection of both generation and storage has been putting strain on the Statement of Works process and causing delays to customers. DNOs have been and are continuing to work with NESO to review and revise the best way to assess the impact of Distributed Generation on the transmission system and to reduce response times and costs, where possible. CUSC Modification CMP298 was implemented in April 2024 and a new Evaluation of Transmission Impact assessment process was implemented. This new process retained the Statement of Works process and introduced a new Transmission Impact Assessment (TIA) process.

In the new process NESO in conjunction with Transmission Owners, are developing planning limits or materiality headroom for Grid Supply Points (GSP) that will be available to DNOs. These planning limits will indicate the available capacity on the transmission system that can be offered for connections without the need for further assessment. This Transmission Impact Assessment may also indicate any associated transmission works that will be required to connect Distributed Generation, along with the timescales and costs associated with such works. For the Distributed Generation customer, this means the DNO can make a Connection Offer without an individual application to the NESO in many cases. This gives applicants more and better information earlier in the process, and greater certainty. Your offer will also detail any associated financial security and liability you will be required to put in place with the DNO for any associated transmission works.

This process was trialled at a number of GSPs, by a number of DNOs, and has been referred to as the “Appendix G process” which had become fairly universally adopted. It is this process that was formally introduced in CMP298.. For more information, please refer to the NESO website and Section 6.5 of the CUSC. NESO gives more information about this process in the ‘Small Embedded Generation’ section of their website.

For more information, please refer to [Section 6.5 of the CUSC](#).

Financial liabilities associated with Transmission Works

The DNO may be required to secure financial sums payable to NESO for transmission works that would not be required if your generation project does not proceed (“final sums liabilities”). The DNO would pass these liabilities on to you as the project developer. Under NESO’s new scheme for connecting generation, the Connect and Manage scheme, the way in which these liabilities are shared between network users changes slightly. You should discuss this issue with your DNO.

Where to Find More Information

You can find out more information about your DNO’s connection charges from their websites:

DNO	Link to Connection Charge Documents
Electricity North West	https://www.enwl.co.uk/get-connected/apply-for-a-new-connection/common-charging-methodology/

Northern Powergrid	https://www.northernpowergrid.com/use-of-system-charges
SP Energy Networks	https://www.spenergynetworks.co.uk/pages/regulation_guidance_leaflets.aspx https://www.spenergynetworks.co.uk/userfiles/file/SPEN_connection_methodology.pdf
SSE	Connections - useful documents - SSEN Charging statements and information - SSEN
UK Power Networks	Distribution Network Operator UK Power Networks
National Grid Electricity Distribution	National Grid Costs and Charging

Ongoing Charges

This section provides:

- An introduction to ongoing charges;
- A summary of Generation Distribution Use of System charges—how they vary and what they cover;
- A summary of metering charges and the parties involved;
- A summary of top-up and stand-by charges; and
- A summary of charges for using the transmission system.

This section discusses Use of System charges, as well as other ongoing charges that may apply to you. Ongoing charges are associated with some of the running costs of your generating equipment.

Depending on the nature of your project these can include:

- Generation Distribution Use of System (UoS) charges;
- Metering charges;
- Top-up and standby charges; and
- Charges for the use of the transmission system.

Use of System charges are levied by the DNO on the supplier, so as a generator you will not be charged these directly. However, this section is included for your information, as Use of System charges may appear as an item on your bill.

Generation Distribution Use of System Charges

Use of System (UoS) charges are ongoing charges, which primarily cover operation and maintenance costs and include an element to cover the costs of ongoing distribution system development including general reinforcement.

All generators with equipment connected at LV and HV are subject to UoS charges under the Common Distribution Charging Methodology (CDCM). Generators with equipment connected at EHV are subject to UoS charges under the EHV Distribution Charging Methodology (EDCM).

These charges can be negative for generation (i.e. credits). Please see the table below for definitions of the terms LV, HV and EHV.

DNOs are obliged to publish documents about their UoS charges. These cover their UoS charging methodology and a statement of what the charges are for both generation and demand customers. You can find these on DNOs' websites. You can find out more about the CDCM and the EDCM from DNOs' websites and [Charging](#)

Arrangements section on Ofgem's website. The EDCM and CDCM charging methodology are governed by the DCUSA and are subject to open governance.

Distribution Use of System charges have recently been the subject of Ofgem's Significant Code Reviews – the Targeted Charging Review (TCR) and the Access and forward-looking charges review. For more information see [Section 9.3](#).

Metering Requirements, Parties and Charges

You may require separate meters for measuring your import and export. There are two categories of meter:

- Half Hourly (HH); and
- Non-Half Hourly (NHH)

They are described in the information box below.

The type of meter will affect:

- The meter charges you pay; and
- The category of UoS charges that apply.

Section L of the Balancing and Settlement Code (BSC) dictates the type of meter you will require. If you are classed as a 'Small Scale Third Party Generating Plant' (currently defined as less than 30kW capacity), you can choose to have a NHH meter. Otherwise, you have to have a HH meter, if the export is to be metered. HH meters provide metering data for each half hour period, and so can be useful for understanding your electricity import or export at different times of the day. However, they have significant costs associated with them.

Provision of NHH meters are the responsibility of the supplier. They will appoint the following Supplier Agents:

- A Meter Operator: installs and maintains the meter;
- A Data Collector who retrieves the data recorded by the meter and calculates your actual or estimated volume of energy consumption; and
- A Data Aggregator who sums up volumes of energy consumed for each supplier and sends the information to a central system for balancing and settlement

If you use HH metering, it is your responsibility to appoint a Meter Operator. You will have to enter into a Meter Operator contract with a meter supplier. The contracts normally last for five years, and the Meter Operator will:

- Provide, Install and maintain your HH meter; and
- Collect data from your HH meter via a communications link such as a telephone line

The provision of meters is open to competition. Details of Meter Operators and their contact details can be found on the Association of Meter Operators website: www.meteroperators.org.uk

There are Codes of Practice which detail technical requirements for Metering Systems. These can be found on [Elexon's website](#).

The cost of Meter Operator agreements and the costs associated with the communication to collect data from your meter can be in the order of several hundred pounds a year. You should consider obtaining quotations from a number of Meter Operators.

Note: in practice suppliers may pay the owner of some smaller Distributed Generation a fixed amount (eg. £/year) instead of installing meters and making payments based on units exported, however this is not permitted when the installed meter has the capability to record import and export separately. This is something you can discuss with your supplier.

Half Hourly (HH) meters and Non-Half Hourly (NHH) meters

Meters record the flow of electricity. There are two main categories of meters; Half Hourly (HH) and Non-Half Hourly (NHH). HH meters are for larger customers; if your generation peak power is greater than 30 kW you have to use a HH meter, if metering export.

NHH meters record total energy passing through the meter, but do not record the times the energy is transferred. Typically, the recorded data would be collected a few times a year, e.g. every quarter. In contrast, HH meters measure and record energy passing through the meter for each half hour period. The data they record is typically collected remotely every day, for example by a telephone line.

Domestic properties are being encouraged to have a smart meter installed. Smart meters record total energy passing through the meter every half hour. The introduction of smart meters should improve consumer awareness of energy consumption and will allow for the introduction of time of use tariffs.

Data from meters is used to determine charges and rewards. For example, to calculate

- Imbalance charges for balancing and settlement;
- Distribution or Transmission UoS charges; and
- Renewables Obligations Certificate rewards.

Top-up and Standby Charges

You may require top-up and standby electricity supplies to supplement the output from your generating units:

- **Top-up supplies** cover any routine shortfall between the output of your generating units and the demand on your site, and are generally used frequently (i.e. you import electricity supply on a regular basis).
- **Standby supplies** cover your demand in exceptional circumstances, such as generation outages (i.e. you import electricity supply on an intermittent basis). Even if you have no on-site demand or customers, standby supplies are usually required to cover the load associated with auxiliary equipment during start-up.

Top-up and standby supplies can be purchased from any electricity supplier, other generators, or directly through market mechanisms such as a power exchange or the Balancing Mechanism.

Charges Applied by NESO

This section covers transmission network use of system charges, balancing services use of system charges and developments of BSUoS charges.

Similar to the distribution UoS charges applied by DNOs to generators and demand customers who use their distribution system, NESO applies Transmission Network Use of System (TNUoS) charges. NESO publishes a Statement of the Use of System Charging Methodology on their website. According to this statement, you will be eligible for TNUoS charges if you are required to hold a generation licence, and you have a Bilateral Embedded Generator Agreement (BEGA). Please see [Section 8.4: The Connection Application: Generation Licensing](#) for more information on agreements with NESO.

The TNUoS charges vary by geographic region. To see what the charges are in your area, refer to the Statement of Use of System Charges on the NESO website. Note that charges can be positive and negative, and that small generators connected at 132 kV in Scotland are eligible for a reduction in TNUoS charges.

Transmission Use of System charges have been subject to two of Ofgem's Significant Code Reviews – the Targeted Charging Review (TCR) and the Access and forward-looking charges review. Refer to the section on Changes to Use of System Charges in [Section 9.3](#) for more information.

NESO is allowed to make charges for balancing service activities; for the role they play in operating the transmission system and balancing the system in real-time. These charges are called Balancing Services Use of System (BSUoS) charges.

The Use of System Charging Methodology states that all CUSC (Connection and Use of System Code) parties are liable for BSUoS charges. Please refer to the CUSC for more information. There are a number of developments to BSUoS charges – refer to the box below.

There have been a number of developments to BSUoS charges, some of which are still ongoing.

In 2021, Ofgem approved modifications to the CUSC so that storage customers only pay BSUoS charges on exports.

Through Ofgem’s Targeted Charging Review (TCR), Distributed Generation will no longer be able to receive payments from suppliers (an embedded benefit) for avoided Balancing Services Charges (see [Section 9.3](#)).

Following the final decision and impact assessment on the Targeted Charging Review in November 2019, a first Balancing Service Task Force concluded that Balancing Services charges should be treated as cost-recovery charges. This led to a second Balancing Services Task Force which investigated (1) Who should be liable for balancing services charges? And (2) How should these charges be recovered? The Second Balancing Services Task Force consulted in summer 2020 and published a report in September 2020.

The Task Force recommended that Balancing Services Charges should be levied on final demand customers only. Levying BSUoS charges onto final demand only will mitigate the existing distortions between GB transmission connected generators who are currently liable for BSUoS charges and interconnected and Distributed Generation who are not.

The Task Force recommended that Balancing Services Charges should be recovered through a charge which is fixed ex ante. The Task Force recommend by majority that the charge should be volumetric (£/MWh). The combination of fixed and notice period should be 14/15 months.

Ofgem has indicated that solutions to deliver the Task Force’s recommendations will be developed through ongoing an ongoing code modification process.

Table 21: Definitions of LV, HV and EHV

Term	Voltage level
LV (Low Voltage)	In general: less than 1 kV. In practice, this means 400/230 V
HV (High Voltage)	In general: 1 kV—22 kV. In practice, this means 6.6, 11 or 20 kV.
EHV (Extra High Voltage)	In general this covers connection to the distribution system at or above 22 kV. In practice this means 33 or 66 kV, (or 132 kV in England and Wales only). Some DNOs may define this slightly differently. See the definition of EHV for your local DNO.

Section 9.3: G99 Type A & Type B-D, Costs and Charges

Changes to Use of System Charges

Ofgem Targeted Charging Review

Ofgem reviewed certain elements of Transmission and Distribution Use of System charges in a Targeted Charging Review (TCR) Significant Code Review (SCR). This is because they had concerns that the current framework for charging may result in inefficient use of the networks and unfair outcomes for consumers. The SCR was set up in response to changes in the nature of generation being connected, with an increasing amount of smaller generation plants. More businesses and households are generating their own electricity onsite, but still rely on the grid for part of their electricity supply.

Ofgem published their decision in December 2019, which resulted in changes to Use of System Charges.

The review considered two main elements of charges:

- Residual charges; and
- Non-locational embedded benefits.

Residual charges are designed to recover sufficient network costs, so that network companies can recover their allowed revenue as determined in price controls with Ofgem. They were not intended as charges to send signals for how the network should be used.

Residual charges currently make up around 50% of DUoS charges (although this varies between DNOs) and 10-15% of a typical electricity bill and are currently largely based on energy consumption from the network. Under the old arrangement customers who reduced their demand from the network with onsite generation could reduce (or avoid) paying these charges, despite still using the network, and these avoided costs were recovered from other customers.

Ofgem's decision is that the distribution residual charge required a change from one based on energy demand to a fixed charge levied on all households and businesses. The charges apply to final demand users (i.e. not including generation-only or storage-only connections). The fixed charges are applied in bands, according to agreed capacity or energy demand and voltage level.

For the distribution residual charge, there is no longer a link to time of consumption through the application of red / amber / green charging periods, although this will continue for the forward-looking element of DUoS charges. This means that customers are no longer able to switch to behind-the-meter generation to reduce the residual element of Use of System charges.

This change impacts on demand customers with onsite generation. This is because customers with onsite generation consume less from the grid, thus reducing the energy-based charge under the old arrangements. However, the impact on bills will depend on how suppliers pass on charges to their customers.

Ofgem Access and Forward-Looking Charges

Ofgem published their final decision on the Access and Forward-Looking Charges Significant Code Review (Access SCR) in May 2022. The Access SCR review aimed to ensure that electricity networks were used efficiently and flexibly, reflected users' needs and allowed consumers to benefit from low carbon technologies while avoiding unnecessary costs on energy bills.

The changes introduced:

- Changes to the distribution connection charging boundary;
- Enhanced choice of interim "access rights" a customer has to the network, pending completion of any required reinforcement, and a new standardised definition for a Curtailable Connection; and

- A new methodology for determining if a connection application relates to a site that is a Speculative Development. Where a site is determined to be a Speculative Development, the developer of such a site pays for all applicable network reinforcement costs.

These changes were implemented via changes to the Distribution Connection and Use of System Agreement (DCUSA). The characteristics of a Speculative Development are given in Schedule 22, paragraph 1.39 of the DCUSA.

The distribution connection charging boundary determines the split between the amount paid by the connecting generator and the wider energy consumer. The changes are designed to:

- Reduce the upfront costs paid by new generation connections when the network requires reinforcement; and
- Retaining and strengthen existing protections for energy consumers.

Under the old arrangements generators who connected to the distribution system and triggered network reinforcement had to pay a proportion of the costs at the connecting voltage level and one voltage level up. For example, if a generator connected at LV and triggered reinforcement at 11kV they contributed towards the reinforcement costs at both voltage levels. The new arrangement means there will be a reduction in the contribution to reinforcement for generation connections as a 'shallow-ish' connecting charging boundary has been introduced.

Generators will contribute to the reinforcement costs at the voltage level of the connection. Electricity storage sites are treated in the same way as generation sites. The High-Cost Cap (HCC) has been retained, above which the customer has to pay in full for the reinforcement costs. This is presently £200/kW for generation and £1720/kVA for demand. If a site has both generation or electricity storage and demand, and the primary purpose of the site relates to demand, it will be charged as a demand customer and make no contribution to reinforcement costs at the voltage of the point of connection. This is summarised in the table below:

Table 22: Summary of reinforcement charging boundaries.

	Charging Boundary	Extension costs	Reinforcement costs at connecting voltage	Reinforcement costs at connecting voltage +1
New arrangement for demand connection and mixed-use sites where generation (storage) and demand are co-located (provided the primary purpose of the site relates to demand)	Fully shallow	Connecting customer pays 100%	Fully funded by DNO through DUoS	Fully funded by DNO through DUoS
New arrangement for generation connection	Shallow-ish	Connecting customers pays 100%	Connecting customer pays a proportion of the reinforcement costs	Fully funded by DNO through DUoS

If the connection of Distributed Generation triggers transmission system reinforcement the costs will continue to be charged to the connecting customer. Ofgem are considering this arrangement in their ongoing use of system work.

The reforms to the connection charging boundary came into effect in 1 April 2023.

For connection applications received by the DNO on or after 1 April 2023 the DNO may offer a curtailable connection to allow a quicker connection to the network. This will include an agreement that your connection may be restricted at certain times until the required reinforcement of the distribution system has been completed. The amount of curtailment in the interim period will be measured and compared against a limit,

established by an agreed methodology, above which the DNO will pay you compensation at a published set price. The curtailment will cease after an agreed end date by which time the necessary network reinforcement should have been completed. Curtailable connections will not be offered to domestic and small industrial and commercial users who have whole current metering. Full details can be found at the following link: <https://www.ofgem.gov.uk/publications/access-and-forward-looking-charges-significant-code-review-decision-and-direction>.

Embedded Benefits

Embedded benefits are historic charging arrangements that had favoured Distributed Generation with a capacity of less than 100 MW, in terms of receiving revenue. There were four non-locational embedded benefits:

1. Transmission Demand Residual (a payment to Distributed Generation): this was the largest benefit of the four and was removed in June 2017;
2. Transmission Generational Residual;
3. Balancing Services Charges – payments from Suppliers; and
4. Balancing Services Charges – avoided charges: currently an avoided charge for Distributed Generation (for capacity < 100 MW)

The decision reached by Ofgem on items (2) and (3) above are as follows. The Transmission Generation Residual, which was previously a payment for transmission connected generation, will be set to zero. And Distributed Generation will no longer be able to receive payments from suppliers for avoided Balancing Services Charges. The removal of these Embedded Benefits affects all grid connected generators who currently benefit from these as a revenue stream.

Further Information

For more information, refer to the Ofgem webpage: [SCR TCR](#) and [Access SCR](#). There is also information on the [Charging Futures website](#).

Section 10: Selling Electricity (Smart Export Guarantee & CFD)

This section introduces the financial incentives for selling electricity onto the distribution system.

Section 10.1: G99, Selling Electricity (Smart Export Guarantee)

This section provides:

- An introduction to the Smart Export Guarantee (SEG) incentive;
- A summary of the eligibility and accreditation arrangements;
- A summary of the deployment caps and how they work; and
- Guidance on where to find more information.

Introduction

Smart Export Guarantees (SEGs) are a financial incentive to support distributed and small-scale renewable energy generation, up to a capacity of 5 MW.

SEGs are available for the following generation technologies:

- Anaerobic digestion (AD);
- CHP and Micro-CHP;
- Hydro;
- Solar PV; and
- Wind.

This section details the structure of the tariffs and will explain how to get accredited with SEGs.

Important Point: The SEG scheme for generators opened on the 1st January 2020. The SEG scheme replaces the Feed-in Tariff (FIT) scheme that closed on the 31st March 2019 but works differently to FITs.

There are two sources of financial benefit from FIT payments which are:

- Generation tariff: A fixed unit for each unit of electricity generated; and
- Export tariff: A guaranteed price for each unit of electricity exported to the grid.

The SEG scheme obliges electricity suppliers to offer an export tariff rate to an eligible generating unit.

Generators cannot receive SEG payments as well as FIT payments for exported electricity. However, if the generator continues to receive FIT generation payments and opts out of receiving FIT export payments then they are eligible to receive SEG export tariff payments.

Tariff Structure

The main financial benefit from a generation project under the SEG scheme is the export tariff, which is a guaranteed price for each unit of electricity exported to the grid. It is an obligation for licensed electricity suppliers to offer eligible generation projects an export tariff rate. The electricity suppliers decide the SEG export tariff details i.e., the rate and the length of the contract. However, although wholesale electricity prices can fall below zero due to changes in demand, electricity suppliers must always offer a tariff which is greater than zero.

The tariffs are variable and can be adjusted annually for inflation. Generators should contact electricity suppliers in the first instance for more information on the SEG scheme and what rates are offered. A full list of the

electricity suppliers that are offering payments have been published by Ofgem, and you can access them on their webpage below:

<https://www.ofgem.gov.uk/publications/list-all-electricity-licensees-including-suppliers>

FIT Scheme – Generation and Export Tariff

Installations which receive payments under the previous FIT scheme will continue to receive the same generation and export tariffs that were current at the time of installation. The last export tariff under the FIT scheme, before the scheme closed on the 31st March 2019, was fixed at 5.24p/kWh. This differs from the export tariff rate offered through the SEG scheme, which depends on the electricity supplier you choose to contract with.

Metering Requirements

All new installations that wish to be paid for electricity exported to the grid must have an export meter installed. The export meter must be capable of taking half-hourly measurements and have an export MPAN (Meter Point Administration Number). The export meter must be located at the point where the installation connects to the distribution system. Smart meters are capable of measuring half-hourly export energy so will not need physically changing.

Your electricity supplier is a good first port of call to discuss metering arrangements. However, note that you can opt to receive SEG payments from a different electricity supplier from your import electricity supplier.

Eligibility and Accreditation

Renewable energy generators under 5 MW are eligible for SEGs.

Accreditation Steps:

For wind or solar PV generation up to and including 50 kW, and for micro-CHP, the accreditation process is as follows:

- Install your generating unit—you must demonstrate that the installation and installer are suitably certified by using a Microgeneration Certification Scheme (MCS) installer (see below);
- Have or arrange to have installed a smart meter to measure export energy every half hour; and
- Apply for a SEG with your electricity supplier, and provide them with any documentation to demonstrate compliance so that they can verify your eligibility.

Your electricity supplier will then be responsible for the level of payment you will receive for the electricity exported, for which you will be required to provide export meter readings. See Ofgem's website below for more guidance on receiving SEG payments:

<https://www.ofgem.gov.uk/environmental-and-social-schemes/smart-export-guarantee-seg>

If your generation equipment is greater than 50 kW, you will be required to demonstrate that the installation is suitably certified. Each electricity supplier will have their own requirements for demonstrating certification, but these are expected to include the EREC G99 Installation Document and proof of ownership.

For all anaerobic digestion and hydro installations, you are required to provide evidence that the installation is suitably certified for a capacity up to and including 5 MW.

For anaerobic digestion installations, an additional step is required to gain accreditation, which involves submitting separate and ongoing documentation to Ofgem, in the form of quarterly sustainability declarations and annual feedstock declarations. Anaerobic digestion installations must use sustainable biogas in order to be eligible for SEG payments. Feedstock that is waste is considered to satisfy sustainability criteria automatically. More information is available on Ofgem's website: <https://www.ofgem.gov.uk/publications/guidance-anaerobic-digestion-generators-seg-sustainability-criteria-and-reporting-requirements>

Microgeneration Certification Scheme (MCS)

The MCS is currently the only formalised industry standard in the UK based on European and international standards for microgeneration projects. MCS is a BS EN ISO/IEC 17065:2012 Certification scheme covering renewable energy products wind and PV up to 50 kW (electrical), solar thermal, biomass and heat pumps up to 45 kW (thermal), Micro CHP and hydropower and renewable energy installation companies. The MCS operator checks the product's performance and quality, the installation methods and quality. Compliance with the MCS requirements should increase your confidence in the renewable energy technology you are buying and in the company installing it.

For more information, please refer to the MCS website: www.microgenerationcertification.org

Multi-technology sites: Electricity suppliers have an obligation to accept a request for SEG payments from a generator that is exporting from an eligible site. However, if the export meter records the energy exported from a combination of eligible and non-eligible sources at the same site, an electricity supplier does not have to make payments. You should check the options and terms from different electricity suppliers carefully.

Extensions to SEG installations: The capacity of a generation unit of one particular technology can be increased. However, if the installed capacity of the generating unit exceeds 5 MW then the electricity supplier does not have to make SEG payments for the export that exceeds 5 MW. If you choose to install extra capacity at your site from a different eligible technology source, then the electricity supplier will recognise this as a separate eligible source and will be able to make payments for the capacity of this technology up to 5 MW. For example, a 7 MW PV solar array and a 3 MW wind farm would be eligible for SEG payments for 5 MW of PV and 3 MW of wind.

Local Flexibility Markets:

A flexibility provider is a user who provides flexibility services by adjusting the way they consume, generate, or store electricity when requested by the electricity networks. This allows network operators to optimise their capacity, whilst remunerating users for providing this service.

The ENA's Open Networks Project developed the UK's local flexibility market through the formulation of procedures and technical specifications, making energy flexibility markets easier to take part in and more coordinated.

More further information visit the ENA page: [Flexibility Services – Energy Networks Association \(ENA\)](#)

<https://www.energynetworks.org/work/open-networks/2017-2022/flexibility-services>.

Where to Find More Information

For more guidance and the most up-to-date information on the Smart Export Guarantee, please see the following organisations' websites:

Ofgem – About Smart Export Guarantee (SEG).

<https://www.ofgem.gov.uk/environmental-and-social-schemes/smart-export-guarantee-seg>

Department for Business, Energy and Industrial Strategy (DESNZ) — The future for small-scale low carbon generation: Smart Export Guarantee – government response.

<https://www.gov.uk/government/consultations/the-future-for-small-scale-low-carbon-generation>

Section 10.2: G99, Contracts for Difference

This section provides:

- An introduction to renewable electricity incentives
- A summary of the Contracts for Difference mechanism
- A summary of The Renewables Obligation closure
- Guidance on where to find more information

Introduction

This section of the Guide focuses on Contracts for Difference (CFD). This is the main financial incentive mechanism for larger low carbon generation schemes. It has replaced the Renewables Obligation, which closed to new applications in March 2017. The Renewables Obligation closure does not affect generation that was already accredited before the relevant closure date.

This section introduces the CFD mechanism, and explains how you, as a generator, can benefit. Key elements of the CFD scheme are introduced. The application process for a CFD is much more complex than for the SEG scheme.

There are various other power trading options for Distributed Generation, including:

- Selling your electricity on the wholesale market or to an electricity supplier;
- Levy Exemption Certificates (LECs);
- Embedded benefits;
- Ancillary services; and
- EU Emissions Trading System (ETS)

Contracts for Difference (CFD)

Introduction

A Contract for Difference is a bilateral contract between a generator and the Low Carbon Contracts Company (LCCC, the CFD counterparty), which is government owned. A generator with a CFD is paid the difference between the “strike price” and the “reference price”. The strike price is an agreed price for electricity reflecting the cost of investing in low carbon generation. The reference price is a measure of the GB market price for electricity.

CFDs require generators to sell electricity into the market as usual. But to reduce their exposure to market prices, the CFD provides a variable “top up” payment. When the strike price is higher than the reference (market) price, the generator receives a payment. At times when the market price exceeds the strike price, the generator is required to pay back the difference, thus protecting consumers from over-payment.

Parties Involved

A number of parties are involved in the CFD mechanism. They include, with examples of their roles:

- Government: writes the policy, specifies the eligibility criteria and sets the budgets and rounds;
- Low Carbon Contracts Company (LCCC): signs the CFD and forecasts CFD payments;
- NESO (Electricity Market Reform (EMR) Delivery Body): runs the system for users to register, submit and manage applications; assesses the eligibility of applicants; and runs the CFD allocation process;
- EMR Settlement Ltd (Settlement Services Provider): collects metering data, calculates payments and manages the settlement of payments between generators and suppliers; and
- Ofgem: regulates NESO as the EMR Delivery Body and determines disputes.

Eligibility

There are a number of eligibility criteria for the CFD, including:

- Meet qualification requirements, e.g. evidence of planning permission, counter signed Connection Offers, generation type;
- Not considered an excluded applicant e.g. in receipt of another subsidy; and
- Provision of other information / data, e.g. incorporation information (details of different parties involved).

CFD Allocation

CFDs are awarded in rounds. During a round, if the specified budget for CFDs is not exceeded, all qualifying applicants will be awarded CFDs. If the budget is exceeded, the Delivery Body will run an auction to allocate CFDs.

Rounds 1 and 2 took place in 2015 and 2017 respectively, and CFDs have been allocated. In Round 1 there were 27 successful applicants, with project installed capacities ranging from 6 to 714 MW, and strike prices ranging from £50 to £119.89 (in 2012 prices). In Round 2 there were 11 successful applicants, with project installed capacities ranging from 50 kW to 1,386 MW, and strike prices ranging from £40 to £74.75 (in 2012 prices). Round 6 closed in 2024. Round 7 will take place in 2025.

NESO publishes a Contract for Difference Interactive Guidance document which provides details on the CFD process. Also see DESNZ and the [EMR Delivery Body](#) websites for the latest information.

Renewables Obligation

The Renewables Obligation closed to all new generating schemes on 31 March 2017. This was previously the main incentive mechanism for larger renewable generation. The closure does not affect capacity accredited before the relevant closure date, which will continue to receive full 20 year support until the end of the scheme in 2037.

There are a number of grace periods, which allow generators to gain accreditation under the Renewables Obligation in certain circumstances after 31 March 2017. The availability of grace periods differs across England and Wales, Scotland and Northern Ireland.

The grace periods are available on [Ofgem's website](#).

Operators that are successful in their grace period application will have the opportunity to apply for accreditation under the Renewables Obligation after the 31 March 2017.

For more information on the closure of the RO, refer to [Ofgem's website](#).

Where to Find More Information

For Contracts for Difference (CFD) refer to the DESNZ website:

<https://www.gov.uk/government/collections/electricity-market-reform-contracts-for-difference>

NESO as the Delivery Body for CFDs has a website:

<https://www.emrdeliverybody.com/cfd/home.aspx>

The Ofgem website has details on the Renewables Obligation closure:

<https://www.ofgem.gov.uk/environmental-programmes/ro/about-ro/ro-closure>

Section 11: G99 Type B-D, Technical and Commercial Interfaces

This section provides:

- An introduction to competition in connections;
- Information about Contestable and Non-contestable work; and
- Information about The National Electricity Registration Scheme (NERS)

Introduction

To construct the assets to connect a generation site to the distribution system, there are two main options:

- **DNO Connection:** the DNO undertakes all the work necessary to provide the connection. Sometimes called a “statutory” or Section 16 connection; and
- **ICP Connection:** an Independent Connections Provider (ICP) provides the ‘contestable work’, and the DNO completes only the ‘non-contestable’ work (see next page for more information).

DNO Provided Connection

You will be charged the cost of the connection works as discussed in [Section 9: Costs and Charges: Connection charges](#). In practice, the DNO will undertake the design of the connection infrastructure, but the installation work may be undertaken by another organisation under contract to the DNO.

ICP Provided Connections

This arrangement to contract with a third party, an ICP, to provide the contestable connection work is known as “Competition in Connections”. The ability to choose a party, from a range of connections providers may bring about some advantages:

- Prices are determined via a competitive market may be lower than where a DNO undertakes the work; and
- There may be a greater opportunity for the timescales to undertake the work to be aligned with the timescales of the rest of your project.

However, there are some implications if an ICP undertaking the contestable work, including:

- Connection work undertaken by ICPs is subject to inspection and approval by the DNO. You will be charged for ICP design approval by the DNO; and
- There is an additional relationship i.e between the ICP and DNO which needs to be managed. This will take time and effort.

See below for information on the Competition in Connections Code of Practice.

Competition in Connection (CiC) Code of Practice (CoP)

In 2014/15 Ofgem conducted a review into the Electricity Connections Market, covering the market for new connections to distribution system, and assessing the effectiveness of competition. Ofgem concluded that DNOs should be required to produce and adhere to a Competition in Connections Code of Practice. The aim of the CiC CoP is to formalise the arrangements between DNOs and ICPs, to allow effective competition for connections, as well as improving consistency in approaches across DNOs. The document is primarily aimed at third-party connection providers, but you may find it of interest. The CiC CoP is published by DNOs at: <https://www.connectionscode.org.uk/>

DNOs also publish the CiC CoP on their websites, as well as annual reports demonstrating their compliance with the CoP.

Contestable and Non-contestable Work

There are certain tasks that DNOs do themselves, so that they can maintain co-ordination and control of their network. This part of the connection work is called Non-contestable work as it is not open to competition. Conversely, the part of the work that is open to competition is referred to as Contestable work.

Each DNO provides its own definition of Contestable and Non-contestable work in their Connection Charging Methodology, available on their website. Although the definitions may vary, they are broadly similar. The table below shows which activities are typically Non-contestable and which are typically Contestable. Note that activities to do with the existing distribution system are Non-contestable. In addition to paying the ICP for carrying out the Contestable work, you will be charged for:

- The costs incurred by the DNO in carrying out the Non-contestable work; and
- The inspection and approval by the DNO of the work carried out by the ICP.

These charges are discussed in [Section 9: Costs and Charges: Connection costs](#).

Table 23: Examples of Contestable and Non-contestable work activities.

	Typical Non-contestable activities	Typical Contestable activities
Activities to do with the existing distribution system	<ul style="list-style-type: none"> • Deciding on the point of connection to the existing network • Live electrical work to connect the new extension to the existing network • Design and construction of reinforcement upstream of point of connection 	
Activities to do with new assets	<ul style="list-style-type: none"> • Obtaining any necessary consents and wayleaves involving exercising statutory powers • Design approval • Inspection, monitoring and testing of Contestable work 	<ul style="list-style-type: none"> • Obtaining wayleaves that do not require the DNO to exercise its statutory powers • Detailed design for on-site works downstream of the point of connection to the existing network • Project managing the connection • Providing materials to DNOs' specification • Cable trenching, installing ducts and other preparation of the site • Carrying out substation building and civil work on-site • Constructing the extension • Recording of work, cable routes and equipment on site and the provision of this information to the DNO • Installing metering and making internal wiring live (this is undertaken by your supplier rather than an ICP)

National Electricity Registration Scheme

Lloyds register operates the National Electricity Registration Scheme (NERS) on behalf of DNOs. Under the NERS, ICPs are assessed and accredited for various items of Contestable work. For example, they may only be accredited for work up to a certain voltage level.

DNOs stipulate that all or most items of Contestable work need to be carried out by accredited ICPs. A list of accredited ICPs can be found on the [Lloyds register website](#).

Some items of Contestable work may not have to be carried out by an accredited ICP, for example cable trenching work on site. Consult your DNO's Connection Charging Methodology for details on which parties can undertake items of work.

Figure 17: Contractual relationships in the connection process.

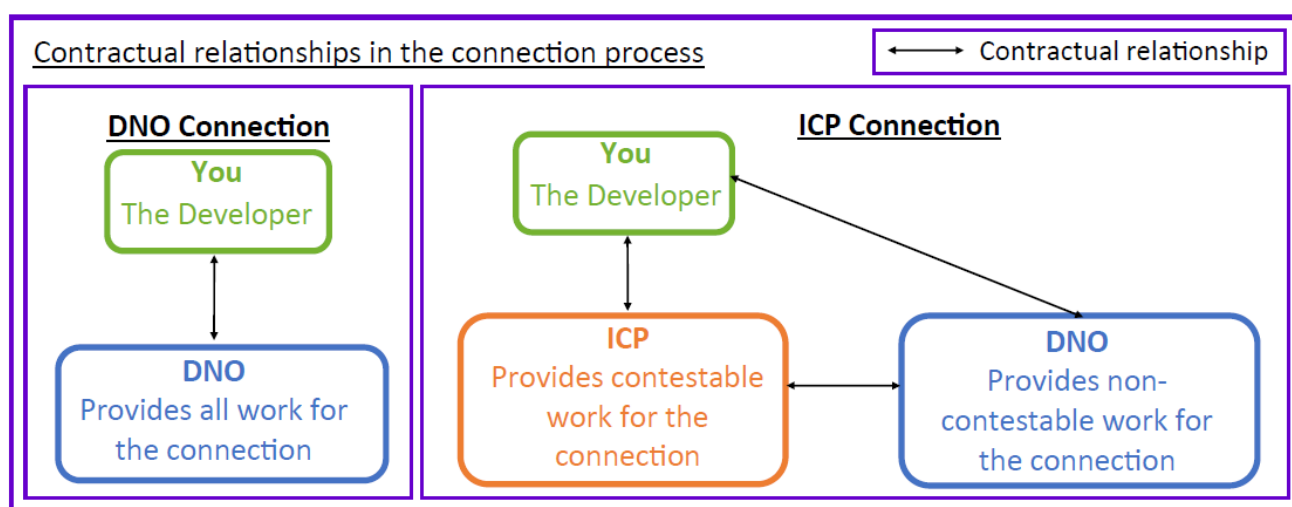

Practicalities of ICP Connections

If you want to get quotations from ICPs for connection work, you first need to establish:

- The scope of the work that is Contestable;
- The relevant standards for the specification of work, materials and equipment; and
- Details of approved contractors.

The DNO defines the scope of Contestable work, although they may be open to negotiation on some points. This is normally provided in the connection quotation if you have requested this information at the application stage.

The DNO will have design standards and specifications for materials and equipment. However, you should be aware that statutory requirements based on national and international standards for connection works are set out in the Distribution Code. DNOs are entitled to seek clear confirmation and proof that these standards are met. They may charge for additional operating costs imposed by equipment that is otherwise unique on their distribution system.

On making a request for a connection quotation, you should indicate to your DNO if you're interested in obtaining ICP quotations for Contestable work and ask for the quotation to show charges for Contestable work and Non-contestable work separately. You could also ask the DNO for details of approved contractors and for their preferred design standards and equipment specifications.

If you decide to contract with an ICP it is your responsibility to ensure that the ICP's work is acceptable to the DNO under the terms of the Adoption Agreement. So before contracting with an ICP, you should ensure that their quotation:

- Covers all the necessary items of work; and
- Provides materials and equipment which comply with the requirements of the Adoption Agreement.

You should keep the DNO fully informed of the source and specification of equipment to be procured or installed. It may be prudent to set up a design review to enable the DNO to formally review and approve the contractor's proposed scope of supply.

Contracts and Agreements

This section provides:

- An introduction to contracts required with the DNO;
- Information on Connection Agreements and Adoption Agreements; and
- Information on the agreements with other parties.

Introduction

Before you can start operating your generating units, you will need to enter into a number of agreements with the DNO, which:

- Will include a Connection Agreement; and
- May include an Adoption Agreement, where you have contracted with an ICP.

These contractual relationships are discussed in this section, and the terms are defined briefly in the information box on the next page.

Connection Agreement

You will be required to enter into a Connection Agreement with your DNO. The Connection Agreement covers the conditions under which your equipment is entitled to be:

- Physically connected to the DNO's network; and
- Remain connected and energised during normal operation of the distribution system.

Examples of some of the other aspects covered in the Connection Agreement include:

- Identifying who is responsible for equipment maintenance and recording failures;
- Recording key technical data such as import and export capacities;
- Specifying the requirements for communication links between you and the DNO; and
- Setting out any obligations on the DNO regarding the connection, and obligations on you such as paying the connection charge and complying with the Distribution Code.

The Connection Agreement is likely to take the form of a standard document with project specific annexes. A first draft will probably be prepared by the DNO for discussion, agreement, and signature. DNOs discuss the Connection Agreement in their Connection Charging Methodology, available on their website.

Adoption Agreements

If you use an ICP to construct the Contestable work for your connection, you will have to enter into an Adoption Agreement. This covers the arrangements for the DNO to take over responsibility for the infrastructure installed by the ICP. It also includes arrangements to ensure that the work meets the DNOs' requirements.

Adoption Agreements take one of several forms:

- A tripartite agreement between you, the DNO and the ICP;
- A bipartite agreement between you and the DNO;
- A bipartite agreement between the DNO and the ICP; and

- A multipartite agreement between you, the DNO, the ICP and any relevant third party landowners.

DNOs discuss the Adoption Agreement in their Connection Charging Methodology, which are available on their websites. You should consult this document to find out which form of agreement your DNO specifies.

Agreements with Other Parties

You may also need to enter into agreements with other parties including:

- Terms for 'Use of System' are either covered by the agreement you will have with your supplier, who is a party to the DCUSA. This is the most likely option.
- Entering into a 'Distribution Connection and Connection and Use of System Code (CUSC). See the CUSC website: <https://www.nationalgrideso.com/industry-information/codes/connection-and-use-system-code-cusc>
- Agreements with NESO, which will be either a 'Bilateral Embedded Generation Agreement' (BEGA) or a 'Bilateral Embedded Licence Exemptible Large Power Station Agreement' (BELLA) (see [Section 4: The Connection Application: Generation Licensing](#))
- A Power Purchase Agreement or an agreement with your supplier for selling your exported electricity; and
- Metering Agreements (see [Section 9: Costs and Charges: Ongoing charges](#))

Agreements at a glance

Connection Offer: A formal offer from the DNO containing terms, conditions and charges for the DNO to make the connection. Issued either to you or the ICP where applicable.

Connection Agreement: An agreement between you and the DNO detailing terms and conditions for connecting to and remaining connected to the DNO's network.

Adoption Agreement: An agreement which sets out the terms and conditions for the DNO to adopt assets which have been constructed by an ICP.

Operational Issues

This section provides:

- An introduction to some operational issues;
- A summary of the Distribution Operating Code requirements; and
- A summary of DNO control schemes.

Introduction

Once your generating units have been connected, you still have some ongoing responsibilities around running your generating equipment. For example, you may need to provide the DNO with forecasts of your generation, or exchange information with them if an unusual event occurs. Although the focus of this Guide is on the connection process for Distributed Generation, this section will also touch on some operational issues.

There are different requirements for different categories of Distributed Generation. These are outlined in a section of the Distribution Code, which is discussed in more detail in this section.

The day-to-day running of your generating equipment may also be impacted by control schemes which your DNO may apply. If your DNO does apply an operational control scheme this will be detailed in your Connection Agreement, so that is the first place you should look. These schemes are discussed briefly, and we will point you in the direction of sources for more information.

Distribution Operating Code

The Distribution Operation Code (DOC) is a section of the Distribution Code. The requirements of the DOC are set out on the next page, and include:

- Operating procedures at the interface between the DNO and users of the distribution system; and
- Requirements for certain users of the distribution system to provide data to the DNO on load forecasts and/or generation output.

The DOC covers ten different aspects of information exchange or procedures. Some will apply to all Distributed Generation, others only to generators of a certain size. For full information on the DOC, please refer to the Distribution Code, which is available free of charge on the Distribution Code website: <https://dcode.org.uk/the-gb-distribution-code-review-panel.html>

The areas covered are summarised in the following table, as well as who they apply to.

Table 24: Summary of DOC sections.

DOC Section	Applies to:	Brief Overview
DOC1	All Distributed Generation over 5 MW, and over 1 MW where the DNO considers it appropriate	Demand forecasting: the generator has to provide generation output forecasts to the DNO.
DOC2	Distributed Generation with output greater than 1 MW	Operational planning: you have to provide an outage program for your Distributed Generation to the DNO, and the DNO provides you with information on possible constraints on their system.
DOC5	All Distributed Generation Medium power stations that don't have an embedded generation agreement	Testing and monitoring: the DNO may need to test the quality of supply or the active / reactive power transfer at your point of connection. If they need to do this they will advise you about it, and you will be able to witness the tests and/or know the results. Up to twice a year, National Energy System Operator (NESO) may ask the DNO to ask Distributed Generation for a statement of compliance with the relevant Grid Code conditions.
DOC6	Not applicable to Distributed Generation	Demand control
DOC7	Distributed Generation connected at HV	Operational Liaison: you and the DNO may need to exchange operational information or information about events. In order to do this, an effective means of communication needs to be established. The DNO needs to be regularly updated with your contact information.
DOC8	All Distributed Generation (excluding offshore)	Safety co-ordination: requirements to ensure the safety of people who may be working on the boundary between the DNO and Distributed Generation.
DOC9	All Distributed Generation (excluding offshore)	Contingency planning: sets out the co-ordination that is needed between all users under abnormal conditions.

DOC10	Distributed Generation connected at HV	Operational event reporting and information supply: you have to report significant events, and where necessary conduct joint investigations with the DNO.
DOC11	All Distributed Generation (excluding offshore)	Numbering and nomenclature of electrical apparatus at ownership boundaries: if you or the DNO install or change apparatus at an ownership boundary the owner of the apparatus must be notified about the numbering and nomenclature.
DOC12	Distributed Generation connected at HV	System tests: if anyone intends to undertake system tests which will affect other users, they need to follow this procedure.

DNO Control Schemes

When distribution systems were built, they were not designed to connect Distributed Generation. Instead, the power system was designed to transmit bulk power from a number of large power stations to the distribution system, and then in turn distribute power from bulk supply points to demand customers.

There has been significant growth in Distributed Generation in recent years. Some distribution systems are reaching the limits of their thermal and fault level capacity to accommodate more generation.

There are several reasons why reinforcements may be required to connect Distributed Generation, including:

- Increased power flows "up" the network means that parts of the network are approaching their thermal limits;
- Changing power flows "up" and "down" the network means that the equipment installed to control network voltage might not work effectively; and
- The currents that would flow in the event of a fault on the network would exceed the capability of the equipment, including protection equipment.

Reinforcement has associated costs, as discussed in [Section 9: Costs and Charges: Connection charges and Costs and Charges: Ongoing charges](#).

Depending on the particular issue, a possible alternative to reinforcement could be for the DNO to deploy control scheme for Distributed Generation. For example, a control scheme may allow Distributed Generation to remain connected under normal operating conditions but under certain operating conditions their output may be constrained. It should also be noted that constraining the output from the generating units can affect the economics of a project.

Glossary of Terms

Distribution Network Operator (DNO): Different DNO organisations own segments of the electricity distribution network across GB.

Generating Unit: Any apparatus which produces electricity.

Generator: A person who generates electricity under licence or exemption under the Electricity Act 1989.

Grid Supply Point (GSP): Any point at which electricity is delivered from the National Electricity Transmission System to the DNO's distribution system.

Independent Distribution Network Operator (IDNO): A holder of a distribution licence, an IDNO designs, builds, owns and operates a distribution system, which is an extension to existing DNO network. They typically build network for new developments such as business parks, retail and residential areas and leisure facilities.

Low Voltage (LV): A voltage normally exceeding 50 V AC between conductors and earth or 120 V DC between conductors but not exceeding 1000 V AC or 1500 V DC between conductors or 600 V AC or 900 V DC between conductors and earth.

Micro-generator: A source of electrical energy and all associated interface equipment able to be connected to an electric circuit in a Low Voltage electrical installation and designed to operate in parallel with a public Low Voltage Distribution Network with nominal currents up to and including 16 A per phase.

National Energy System Operator (NESO): The Electricity System Operator for GB. Their role is to ensure that supply and demand is balanced on a minute-by-minute basis. The UK's 2023 Energy Act established an independent system operator, and facilitated the creation of NESO. NESO was created based on the National Grid Electricity System Operator.

National Grid Electricity Transmission (NGET): Owns the electricity transmission network in England and Wales. NGET is a member of the National Grid group of companies.

Ofgem: The Office of Gas and Electricity Markets.

Reinforcement: Reinforcement work is usually required to increase the electrical capacity of those parts of the network which are affected by the introduction of new generation or demand. Other work might include upgrading the switchgear at a substation some distance from the proposed generation project, due to the increase in fault level caused by the connection of generating equipment.

Renewable Obligation Certificates (ROCs): A green certificate issued to an accredited generator for eligible renewable energy generated within the UK and supplied to customers within the UK by a licensed electricity supplier. ROCs are issued for each MWh of eligible renewable output generated, the amount of ROCs received depend on the technology of the generating unit.

Retail Price Index (RPI): General purpose measure of inflation used in the UK.

Reverse Power Flows: Power flows in the opposite direction to those associated with the consumption of electricity by users.

Site Responsibility Schedule: Also called a Joint Operational Agreement. A schedule defining the ownership, operation and maintenance responsibility of equipment and apparatus at the Point of Supply with the DNO.

Supplier (Electricity Supplier): Electricity suppliers purchase electricity (on the market or in contracts) and sell electricity to customers (commercial, industrial and domestic).

System Voltage: The voltage at which an electrical network is operated.

Scottish Power Transmission plc: Owns the electricity transmission network in Central & Southern Scotland.

Scottish Hydro Electric Transmission plc: Owns the electricity transmission network in Northern Scotland

Thermal Rating: The current-carrying capacity of a cable, an overhead line or any other item of electrical infrastructure, which is determined by the heating effect arising from electrical losses.

Transmission System: A system of electricity lines and equipment owned by the holder of a Transmission Licence and operated by NEMO which interconnects transmission connected power stations and substations. In England and Wales the transmission system is the equipment principally rated above 132 kV while in Scotland they are those principally at or above 132 kV.

Type Tested Equipment: Equipment that has been tested in accordance to ensure that it meets the requirements of EREC G98 or G99. Using type tested equipment simplifies the connection and commissioning process.

Use of System (UoS): The use of a transmission or distribution system by a generator, supplier, customer or an interconnected party for the purposes of transporting electricity.

Voltage Flicker: Voltage flicker is a deviation in system voltage, where power is not completely lost. Flicker may be defined as the sensation experienced by the human eye when illumination levels change as a result of the change in voltage.

Voltage Fluctuation: Fluctuations in the supply voltage that can be caused by a fluctuating load, and which in turn cause flicker.

Voltage Unbalance: Occurs where there exists a difference in voltage magnitude between phases and/or a shift in the phase separation from 120° (for a three-phase system).

Appendix A

Examples showing the process for inverter sizing, determining and clarifying registered capacity

Example 1

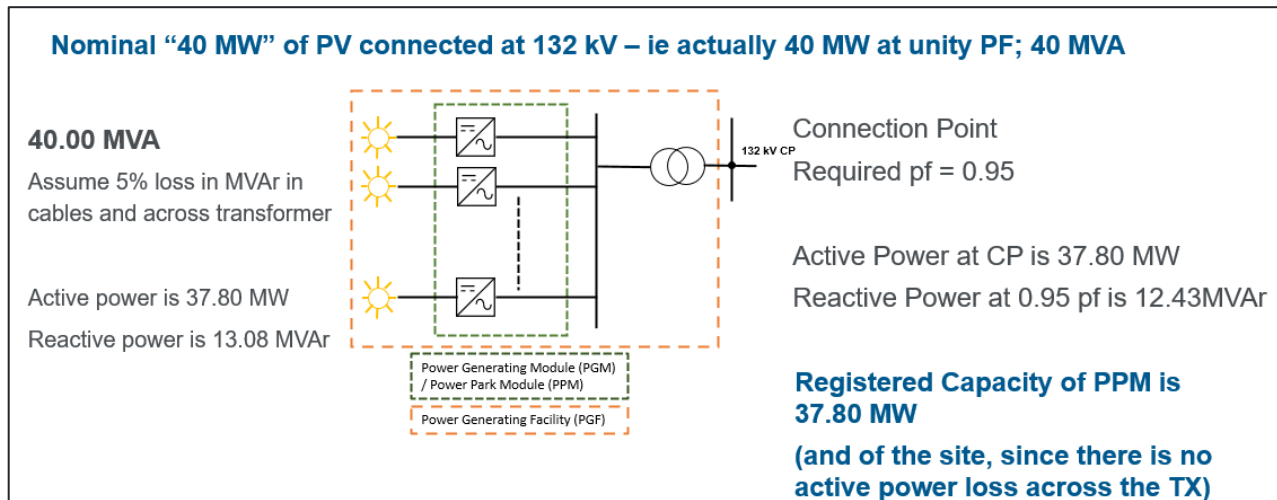

Nominal 40 MW of solar PV connected at 132kV, which assuming unity power factor (pf) is 40 MVA
Assume 5% loss in MVA in cables and across transformer and required pf = 0.95 at the Connection Point.
This requires generator active power output of 37.80 MW and reactive power output of 13.08 MVA.
For 37.80 MW of active power at the Connection Point this generates 12.34 MVA of reactive power.
Registered Capacity of the PPM is 37.80 MW (and of the site, assuming there is no active power loss across the transformer).

Example 2:

If at least 40 MW is to be exported:

Assume 5% loss in MVar in cables and across transformer

40.00 MW
13.84 MVar
42.33 MVA

40.00 MW
Connection Point
0.95 pf
Required reactive power 13.15 MVar
42.11 MVA

Registered Capacity of facility is 40.00 MW

Need to have 42.33 MVA of inverter capacity.

40 MW is to be exported to the network.

Assume 5% loss in MVar in cables and across transformer. This generates 13.84 MVar and 42.33 MVA.

40 MW at the Connection Point with 0.95 PF requires 13.15 MVar and 42.11 MVA.

The total registered capacity of the facility is 40 MW. Need to have 42.33 MVA of inverter capacity.

Example 3:

If at least 40MW is to be exported and TX losses are not negligible:

43.10 MVA
Assume 2% loss in MW and 5% loss in MVA_r in cables and across transformer

Active power is 40.82 MW
Reactive power is 13.85 MVA_r

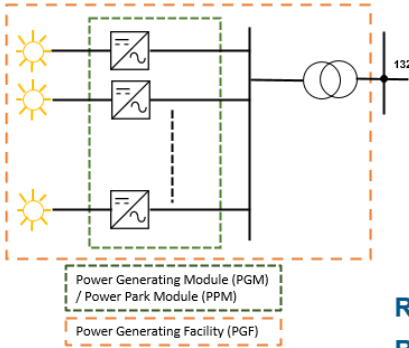

Connection Point
Required pf = 0.95

Active Power at CP is 40.00 MW
Reactive Power at 0.95 pf is 13.15 MVA_r

Registered Capacity of PGM is 40.82 MW
Registered Capacity of facility is 40.00 MW

Need to have 43.10 MVA of inverter capacity.

At least 40 MW is to be exported and transformer losses are not negligible.

Assume 2% loss in MW and 5% loss in MVA_r in cables and across transformers. This produced Active power of 40.82 MW, reactive power of 13.85 MVA_r and apparent power of 43.10 MVA.

40 MW at the Connection Point with 0.95 PF requires 13.15 MVA_r.

Registered Capacity of PGM is 40.82 MW.

Registered Capacity of facility is 40 MW.

Need to have 43.10 MVA of inverter capacity.

Example 4:

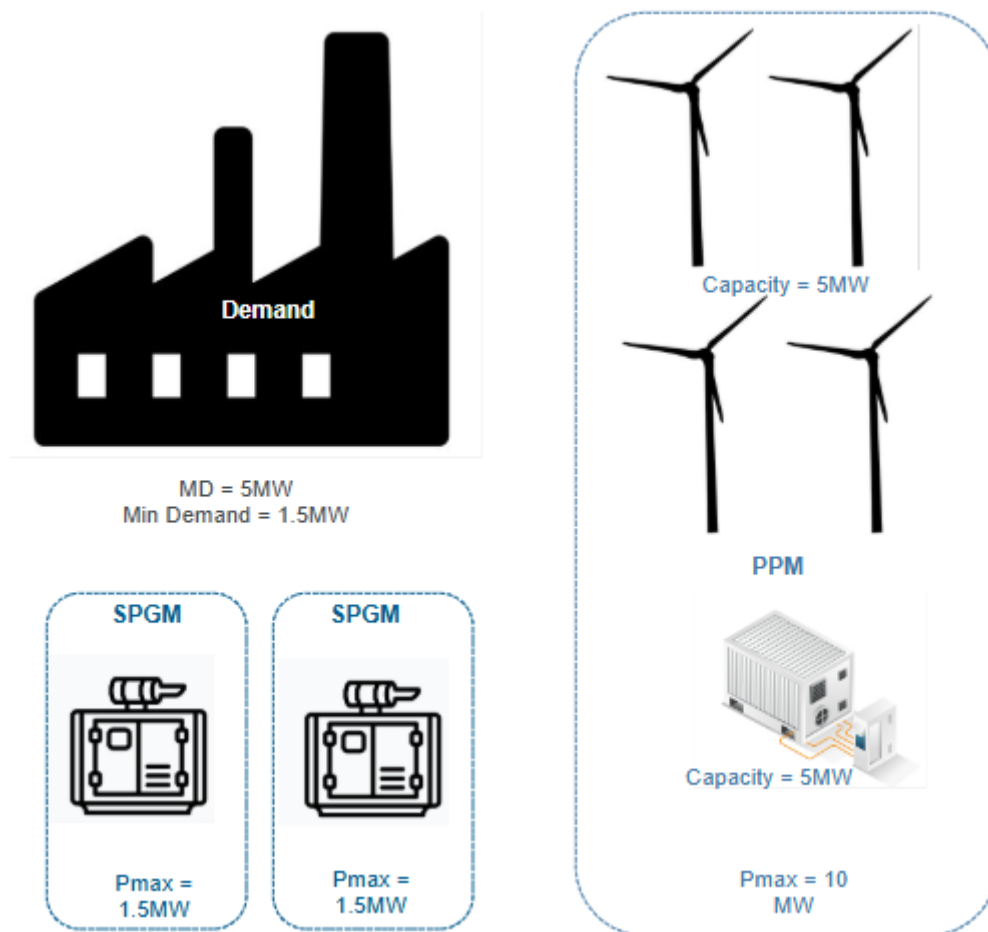

The facility has 3 PGMs – two SPGMs of 1.5MW Registered Capacity each, and one PPM (wind and storage) of 10MW Registered Capacity.

The Connection Agreement would record (not define) these three values of Registered Capacity.

The Connection Agreement would also record the Maximum Import Capacity (MIC) and the Maximum Export Capacity (MEC) for the Power Generating Facility. These values are commercially negotiable and relate to the capability of the DNOs distribution system.

In this case it might be that the MIC is 5MW and the MEC is 8MW.

Because of the variability of the site demand, and the operating regime of the generation on the site, there is no direct link between any of the Registered Capacity values and the MIC and MEC.

The Registered Capacity of the site is 13MW – and is therefore considered as:

Small power station with respect to NGET (England and Wales region) and SPT (Southern Scotland region).

Large power station with respect to SSEN-T (Northern Scotland region).

Applicants should refer to GC0117 modifications in the future in relation to the classification of small, medium and large power stations in GB.

Installer Guidance

This section explains the type of load management and flexibility devices that can help manage a domestic property demand and generation.

These load management techniques can effectively manage demand and generation on a domestic property. For instance, load-limiting devices and load shedders can ensure a property doesn't exceed its agreed export limits when solar panels or other generation may result in export to the distribution system. When applied to generation, these techniques can be used to maintain a stable balance between the production and distribution of energy within the property, as well as manage the energy exported back to the distribution system. This is particularly valuable in homes with renewable energy sources like solar panels or wind turbines, where energy production can be unpredictable and varies with environmental conditions. These techniques provide a flexible and adaptable framework for managing both consumption and generation of energy in a domestic setting.

Solution	Description	Most Applicable Scenario
Load-limiting devices	Restricting the amount of energy, a single property can draw from the network. Each load limiting / management device must be defined, and the application of load management specified. All devices and installations must meet specific standards, in accordance with EREC G100. Additional features: Audio alerts for excessive usage and physical limitations on energy draw.	Useful for retrofitted properties, premises with high overall loads, Also applicable for premises supplied via cables with insufficient capacity or looped services.
Load shedders	Restricting the amount of energy, selected customer device(s) can draw when electrical demand exceeds a predetermined level. Additional features: Audio alerts for excessive usage and physical limitations on energy draw.	Customer wishes to determine which non-essential devices can be subjected to load shedding. Options include: <ol style="list-style-type: none"> 1. Prioritisation of heat pump operation, over EV charging - EV turns on once there is sufficient PV generation or heat pump demand reduction. 2. Use of a G100 device for management of the load automatic process/switching.
Heat Pumps: Thermal Storage	A complimentary system used when there is a need to reserve power draw for other devices. This solution can work around predetermined times that will not infringe on critical customer schedules.	Useful for large domestic houses, such as multi-bedroomed properties or additional installations which expand the heating network. Also applicable based on customer affordability.
Heat Pumps: Immersion Heater (For Legionnaires)	Setting different times (when a customer is not using a device	Use the last digit of the serial number of the HP, to determine

	with high load draw) across multiple/any installation for the heat to initiate.	the hour when the immersion heater will activate, to randomise the activation time. Activation to be only between Midnight and 7am, to avail of off peak tariffs. If the SN ends in an 8 or 9, use the next digit to the left. If that digit is also an 8 or 9, keep going to the next digit to the left until you get a digit between 0 and 7. This will be the hour to set the immersion heater activation. This digit will also be the day of the week, so a SN ending in a 6 will be set to activate at 6am on a Saturday (assuming Monday is day 1)
Backup heat: Increasing room/water temperature	Activated when the heat pump is unable to maintain the desired temperature due to very low outdoor temperatures or system malfunctions.	Harsh cold temperatures where heat pumps may struggle to maintain desired indoor temperatures. It's also applicable in any setting with a heat pump where there's a risk of malfunction (due to hardware/not enough capacity available).
Installation of additional sub-panels	<i>Most properties have a singular main panel for power distribution between all circuits. Use alternative panels for easier load distribution management.</i>	Properties with complex electrical needs Homes with extensive home automation systems, multiple LCTs, or outbuildings that require power. Customer confirmed to prioritise devices in times of excess load.
Upgrading to a three-phase supply (subject to excessive of 100A/23kVA/small service cables/looped services)	Installer will accommodate environments/situation of customer/location. They will use a referred document to check which cable services/cut out apply and their respective ratings.	Property registered for use of APIs/data/Identify Power requirements are significant Single-phase supply is insufficient
Installation of a battery/ G100 device	G100 load limiting technology, which effectively manages power where the system can regulate and limit the load to prevent overloading and potential damage.	Where the customer demand could exceed the capacity of the distribution system.
Request to DNO for reinforcement	The installer recommends that reinforcement is ultimately required due to the increased load	When no other previous solution is applicable to the customers' situation. Significant additional load in a local area.

	and is responsible for the explanation/justification to DNO.	
Removal of deterministic solutions once reinforcement/upgrade is completed	After the notification of increased capacity, if the customer decides to remove the solution, it becomes their responsibility to recontact the installer	All scenarios, should the customer want to fully utilise the equipment that they have paid to be installed.

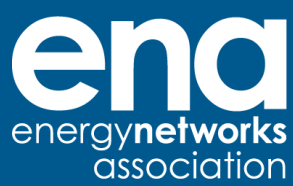

Energy Networks Association

4 More London Riverside

London SE1 2AU

t. +44 (0)20 4599 7700

w. energynetworks.org

 @EnergyNetworks

© ENA 2025

Energy Networks Association Limited is a company registered in England & Wales No. 04832301
Registered office: 4 More London Riverside, London, SE1 2AU